

TIB-S

Nummeret på sidste indsatte rettelsesblad

| | | | | | | | | | |
|------|------|------|------|------|------|------|------|------|------|
| 1 | 5 | 73 | 78 | 80 | 82 | 84 | 90 | 92 | 96 |
| 4 | 72 | 77 | 79 | 81 | 83 | 89 | 91 | 95 | 102 |
| 103 | 110 | 118 | 120 | 121 | 128 | 130 | 132 | 134 | 136 |
| 109 | 117 | 119 | | 127 | 129 | 131 | 133 | 135 | 137 |
| 138 | 140 | 348 | 349 | 353 | 369 | 371 | 372 | 373 | 423 |
| 139 | 347 | | 352 | 368 | 370 | | | 422 | 441 |
| 442 | 444 | 454 | 461 | 463 | 464 | 478 | 491 | 495 | 508 |
| 443 | 453 | 460 | 462 | | 477 | 490 | 494 | 507 | 509 |
| 510 | 511 | 521 | 523 | 528 | 530 | 544 | 545 | 546 | 550 |
| | 520 | 522 | 527 | 529 | 543 | | | 549 | |
| 551 | 553 | 555 | 561 | 579 | 589 | 599 | 603 | 611 | 615 |
| 552 | 554 | 560 | 578 | 588 | 598 | 602 | 610 | 614 | |
| 616 | 621 | 622 | 626 | 630 | 631 | 637 | 640 | 642 | 651 |
| 620 | | 625 | 629 | | 636 | 639 | 641 | 650 | 669 |
| 670 | 681 | 684 | 691 | 693 | 696 | 698 | 704 | 708 | 712 |
| 680 | 683 | 690 | 692 | 695 | 697 | 703 | 707 | 711 | 717 |
| 718 | 724 | 725 | 728 | 733 | 735 | 738 | 739 | 747 | 772 |
| 723 | | 727 | 732 | 734 | 737 | | 746 | 771 | 773 |
| 774 | 780 | 782 | 794 | 796 | 798 | 801 | 804 | 806 | 815 |
| 779 | 781 | 793 | 795 | 797 | 800 | 803 | 805 | 814 | 819 |
| 820 | 822 | 823 | 825 | 829 | 831 | 833 | 876 | 914 | 937 |
| 821 | | 824 | 828 | 830 | 832 | 875 | 913 | 936 | 971 |
| 972 | 1014 | 1069 | 1078 | 1083 | 1085 | 1086 | 1088 | 1129 | 1133 |
| 1013 | 1068 | 1077 | 1082 | 1084 | | 1087 | 1128 | 1132 | 1135 |
| 1136 | 1140 | 1156 | 1171 | 1181 | 1186 | 1198 | 1218 | 1254 | 1255 |
| 1139 | 1155 | 1170 | 1180 | 1185 | 1197 | 1217 | 1253 | | 1257 |
| 1258 | 1263 | 1265 | 1266 | 1270 | 1277 | 1281 | 1286 | 1287 | 1289 |
| 1262 | 1264 | | 1269 | 1276 | 1280 | 1285 | | 1288 | 1297 |
| 1298 | 1302 | 1304 | 1305 | 1307 | 1309 | 1324 | 1328 | 1329 | 1331 |
| 1301 | 1303 | | 1306 | 1308 | 1323 | 1327 | | 1330 | 1332 |
| 1333 | 1334 | 1340 | 1341 | 1345 | 1346 | 1349 | 1351 | 1362 | 1370 |
| | 1339 | | 1344 | | 1348 | 1350 | 1361 | 1369 | 1376 |
| 1377 | 1379 | 1380 | 1382 | 1386 | 1415 | 1416 | 1421 | 1423 | 1425 |
| 1378 | | 1381 | 1385 | 1414 | | 1420 | 1422 | 1424 | |
| 1426 | 1494 | 1496 | 1503 | 1504 | 1517 | 1520 | 1532 | 1534 | 1536 |
| 1493 | 1495 | 1502 | | 1516 | 1519 | 1531 | 1533 | 1535 | |
| 1537 | 1545 | 1547 | 1552 | 1560 | 1565 | 1576 | 1578 | 1580 | 1582 |
| 1544 | 1546 | 1551 | 1559 | 1564 | 1575 | 1577 | 1579 | 1581 | 1590 |
| 1591 | 1593 | 1595 | 1596 | 1597 | 1603 | 1609 | 1619 | 1625 | 1634 |
| 1592 | 1594 | | | 1602 | 1608 | 1618 | 1624 | 1633 | |

1. København H - Fredericia / Taulov

FC Ro Øst
linjeblok
stigning L

120

Kværkeby (Ky)
km 56,6
FC Ro Øst

km 61,5

km 57,8

km 55,9

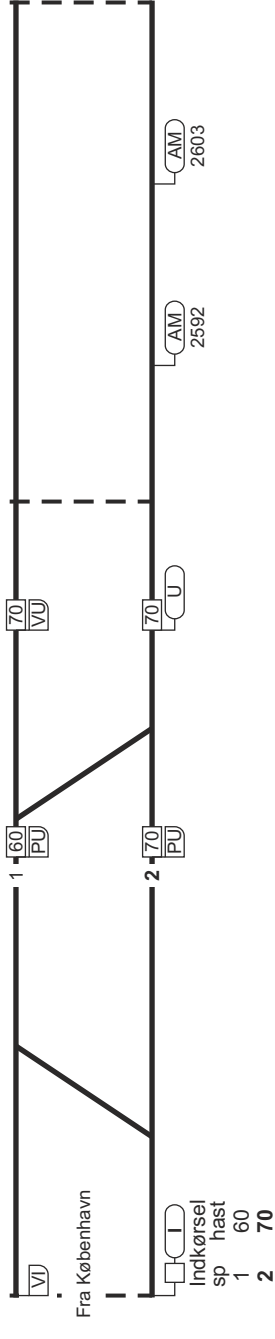

1. København H - Fredericia / Taulov

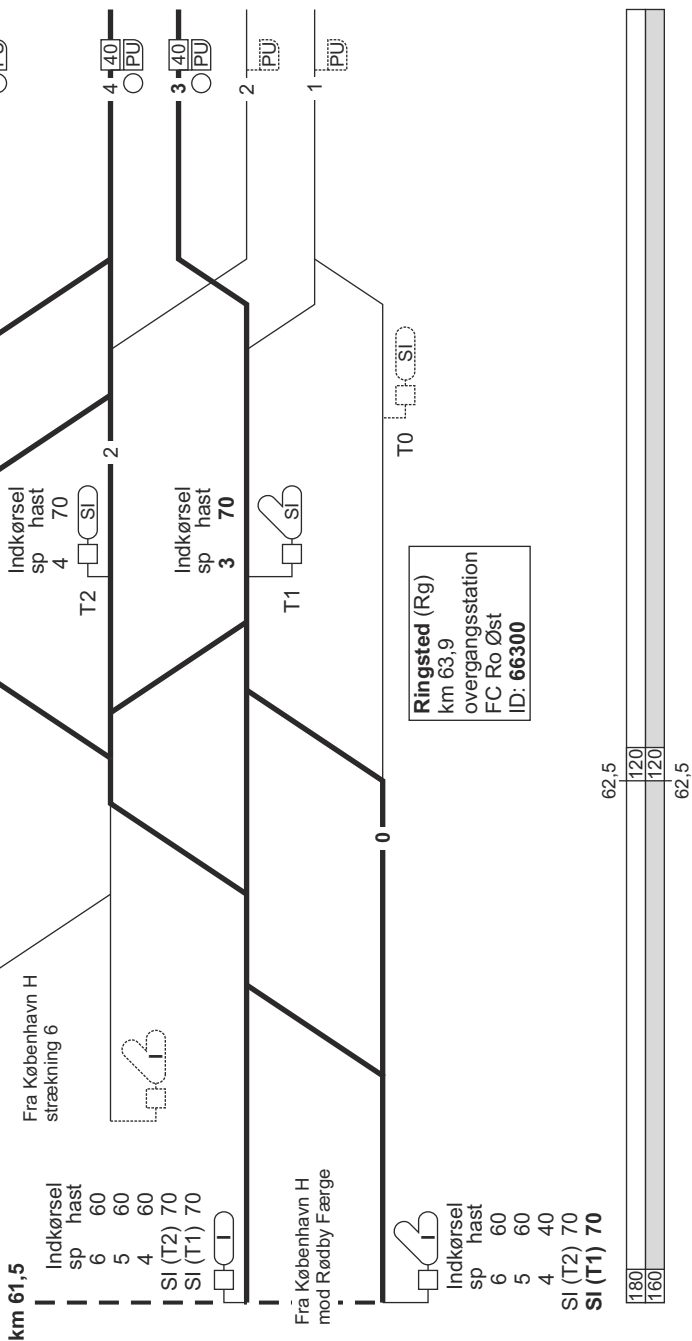

1. København H - Fredericia / Taulov

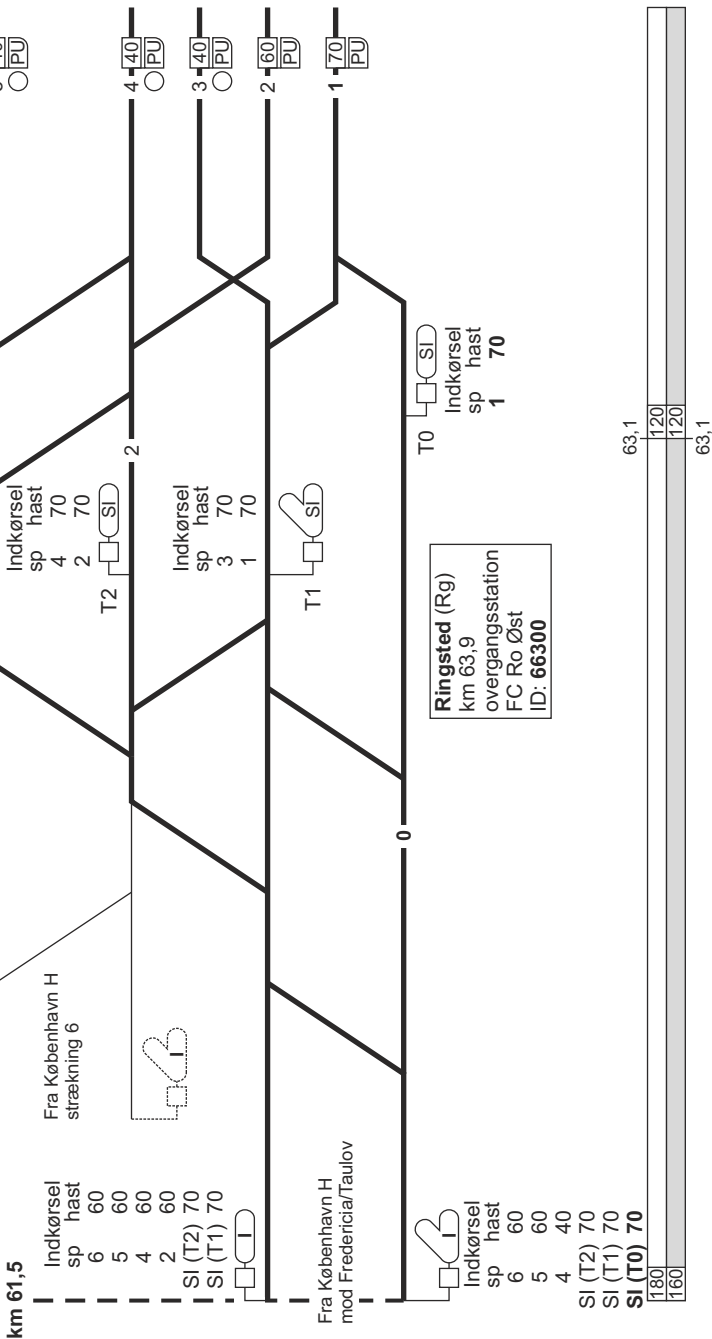

1. København H - Fredericia / Taulov

120

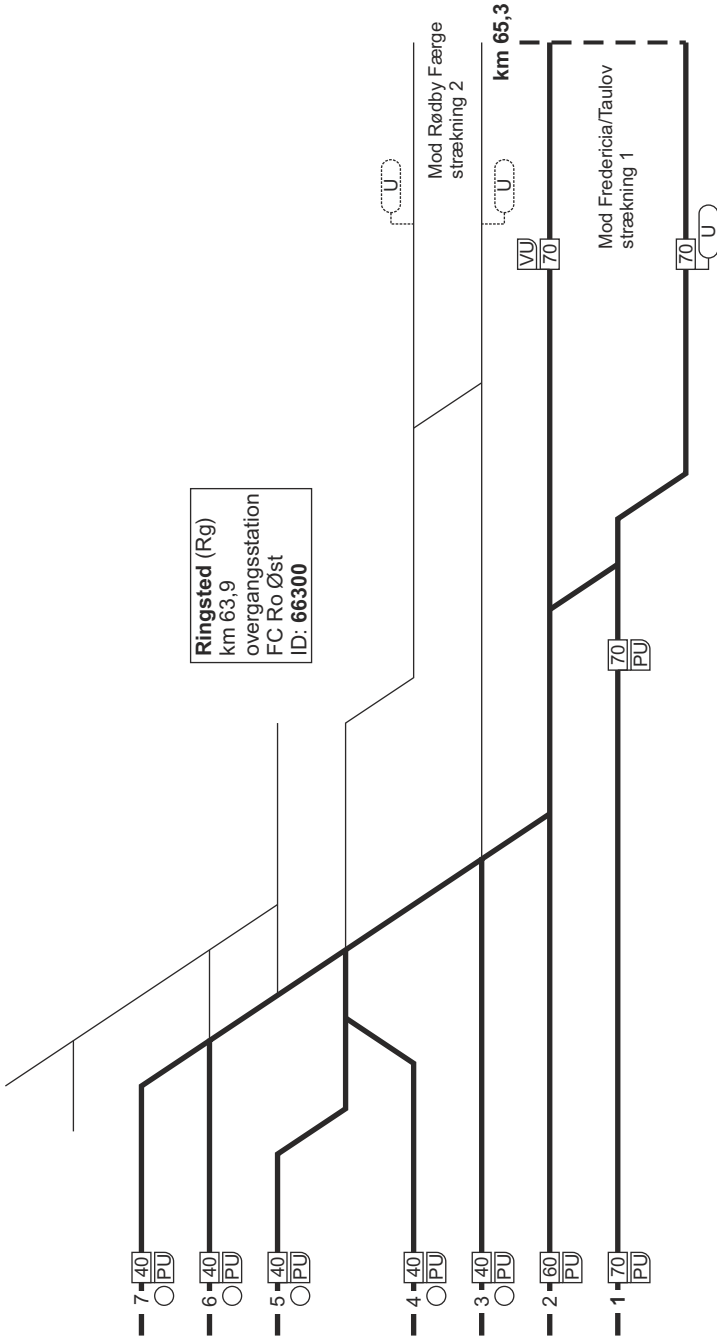

Ringsted (Rg)
km 63,9
overgangsstation
FC Ro Øst
ID: 66300

Mod Rødby Færges
strækning 2

Mod Fredericia/Taulov
strækning 1

km 65,3

64,9

180

160

64,9

120

120

1. København H - Fredericia / Taulov

FC Ro Vest
linjeblok
stigning M

FC Ro Vest
linjeblok
stigning M

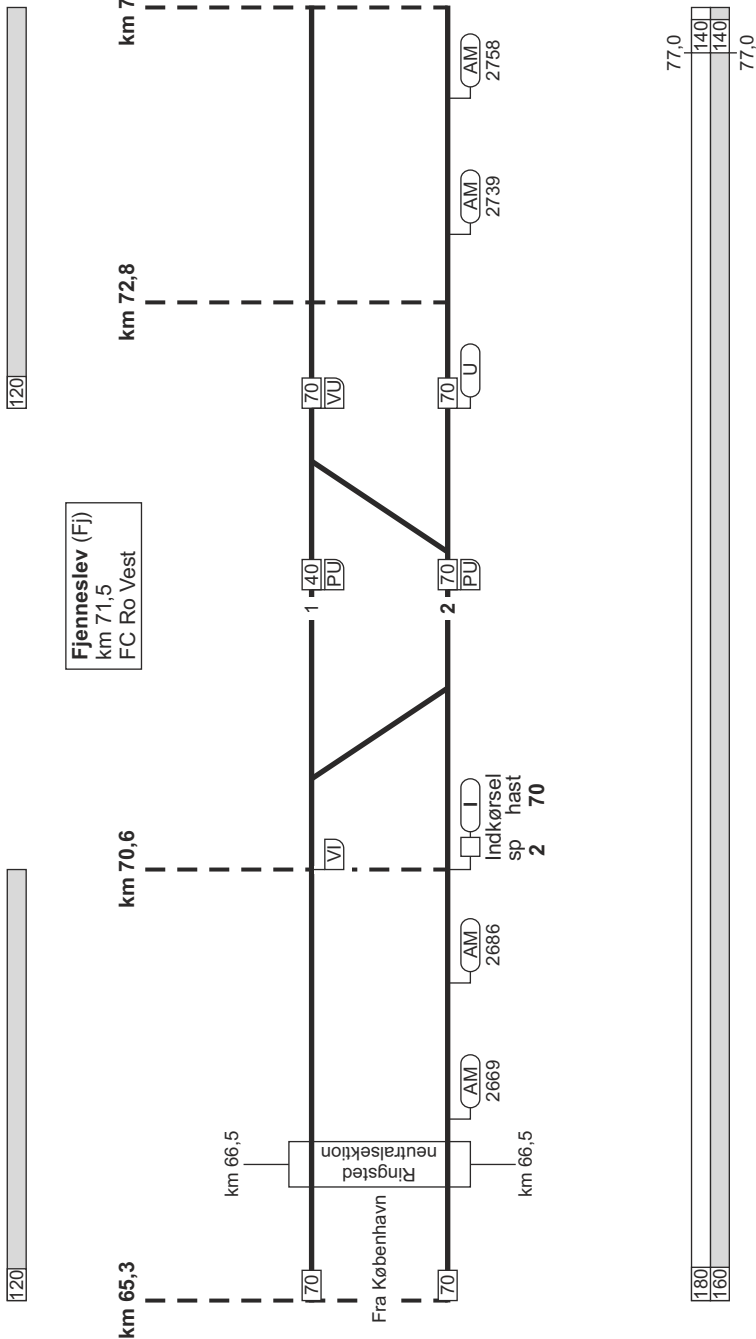

1. København H - Fredericia / Taulov

05.10.2020

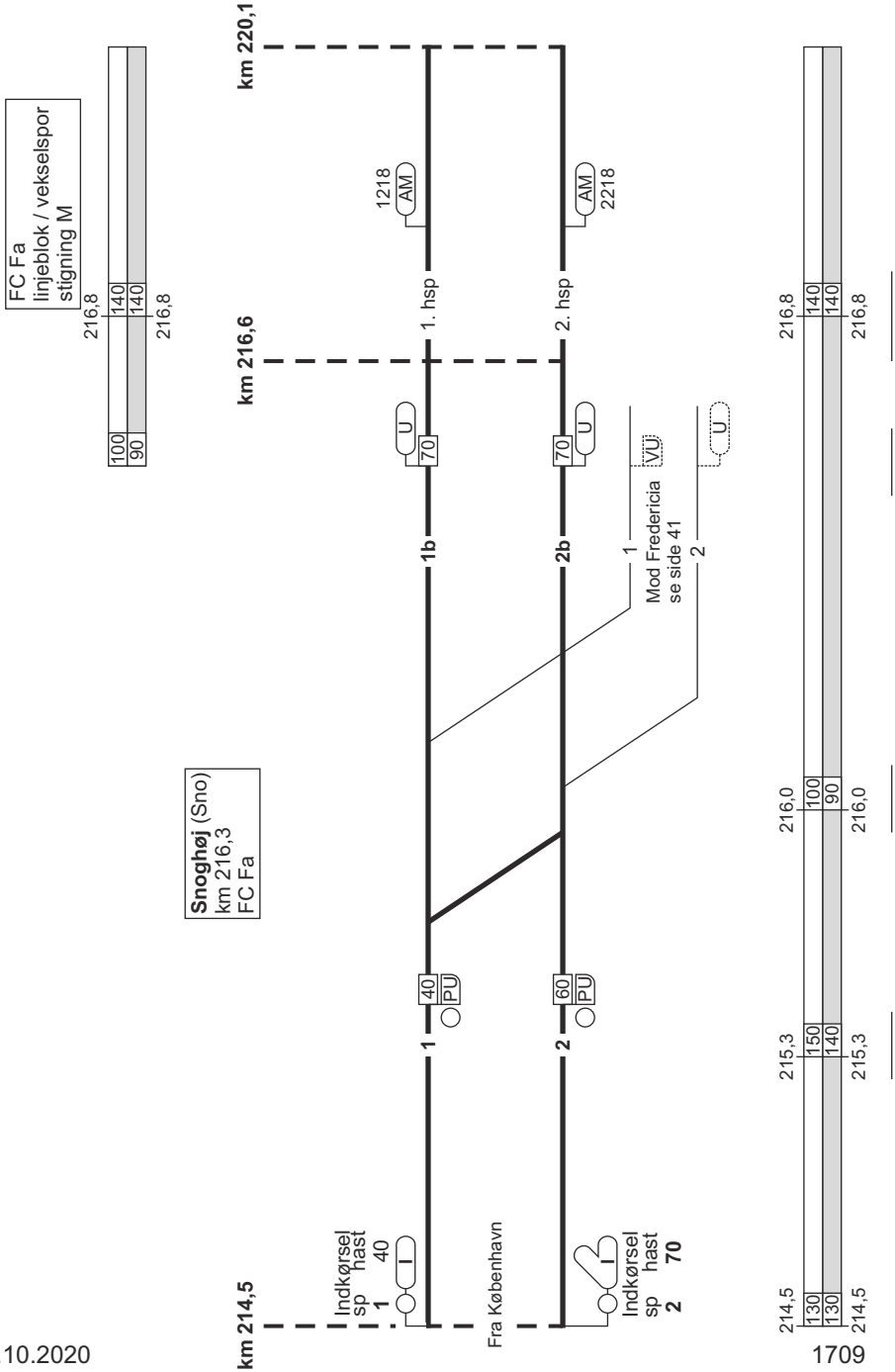

1709

1. Taulov / Fredericia - København H

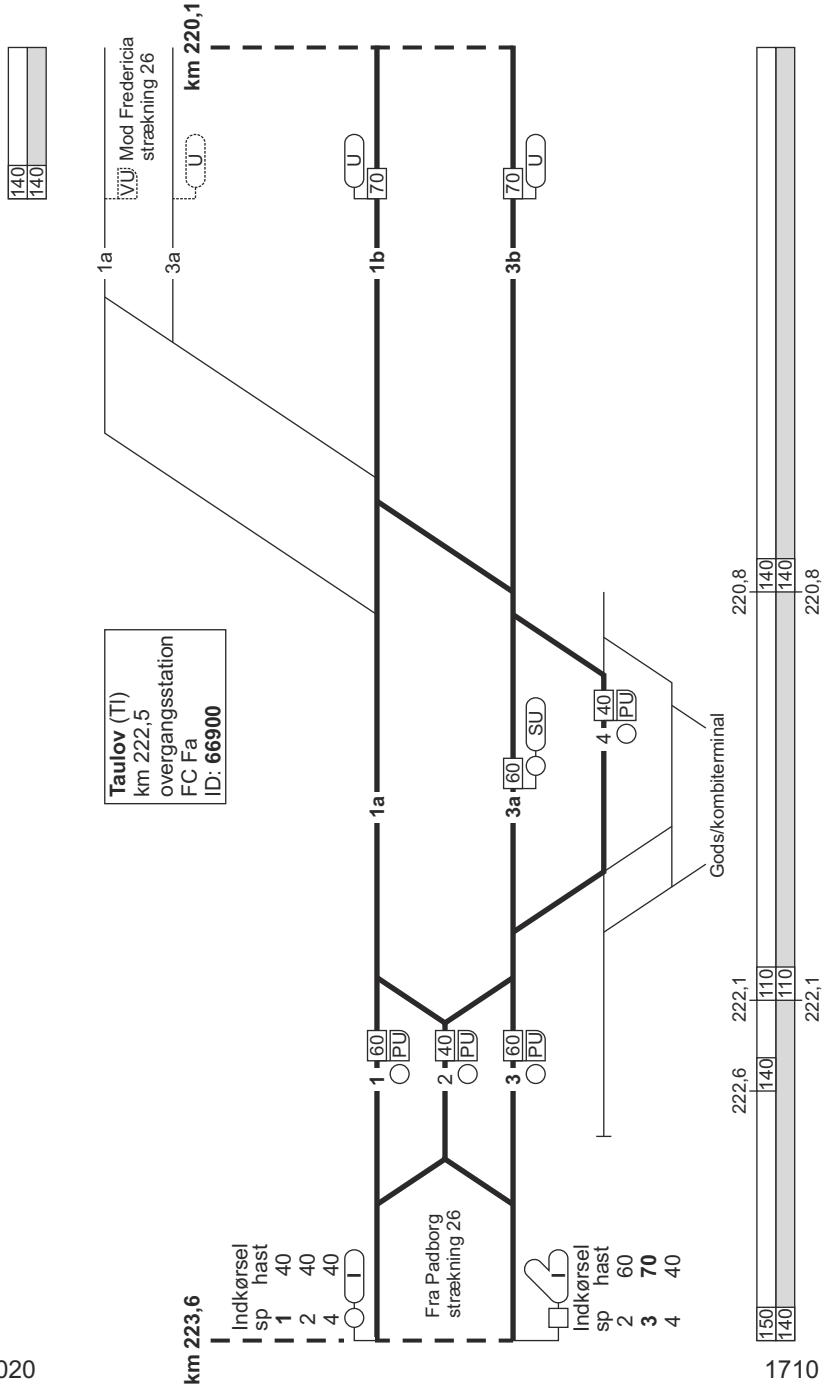

1. Taulov / Fredericia - København H

FC Fa
linjeblok / vekselspor
stigning M

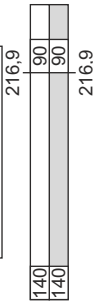

Snoghøj (Sno)
km 216,3
FC Fa

Fra Fredericia
se side 48

km 214,5

km 220,1

km 216,6

Indkørsel
sp hast
2 70
1 40

2219
AM

[70] 2. hsp

Fra Taulov

Indkørsel
sp hast
1 70

1219
AM

[70] 1. hsp

VU
70

2

2b

1

1b

70



216,7



215,9



216,7

215,9

1. Taulov / Fredericia - København H

km 65,3

Indkørsel
sp
hast
1-6 40

Ringsted (Rg)
km 63,9
overgangsstation
FC Ro Øst
ID: 66300

Fra Taulov/Fredericia
mod København H strækning 6

Indkørsel
sp
hast
2 70
3 40
4 40
5 40
6 40

Fra Rødby Færge
strækning 2



64,9

| | |
|-----|-----|
| 180 | 120 |
| 160 | 120 |

64,9

1. Taulov / Fredericia - København H

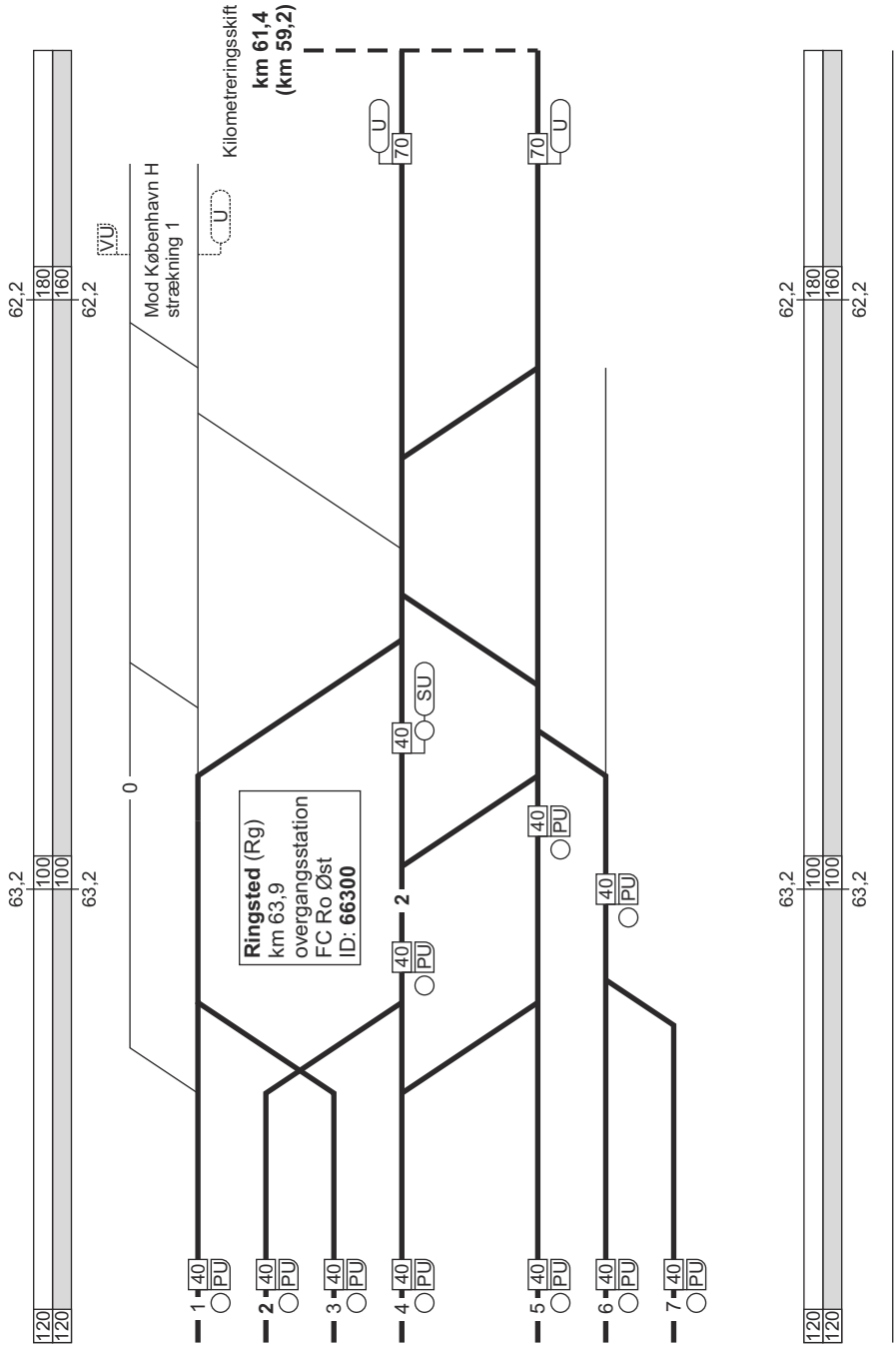

1. Taulov / Fredericia - København H

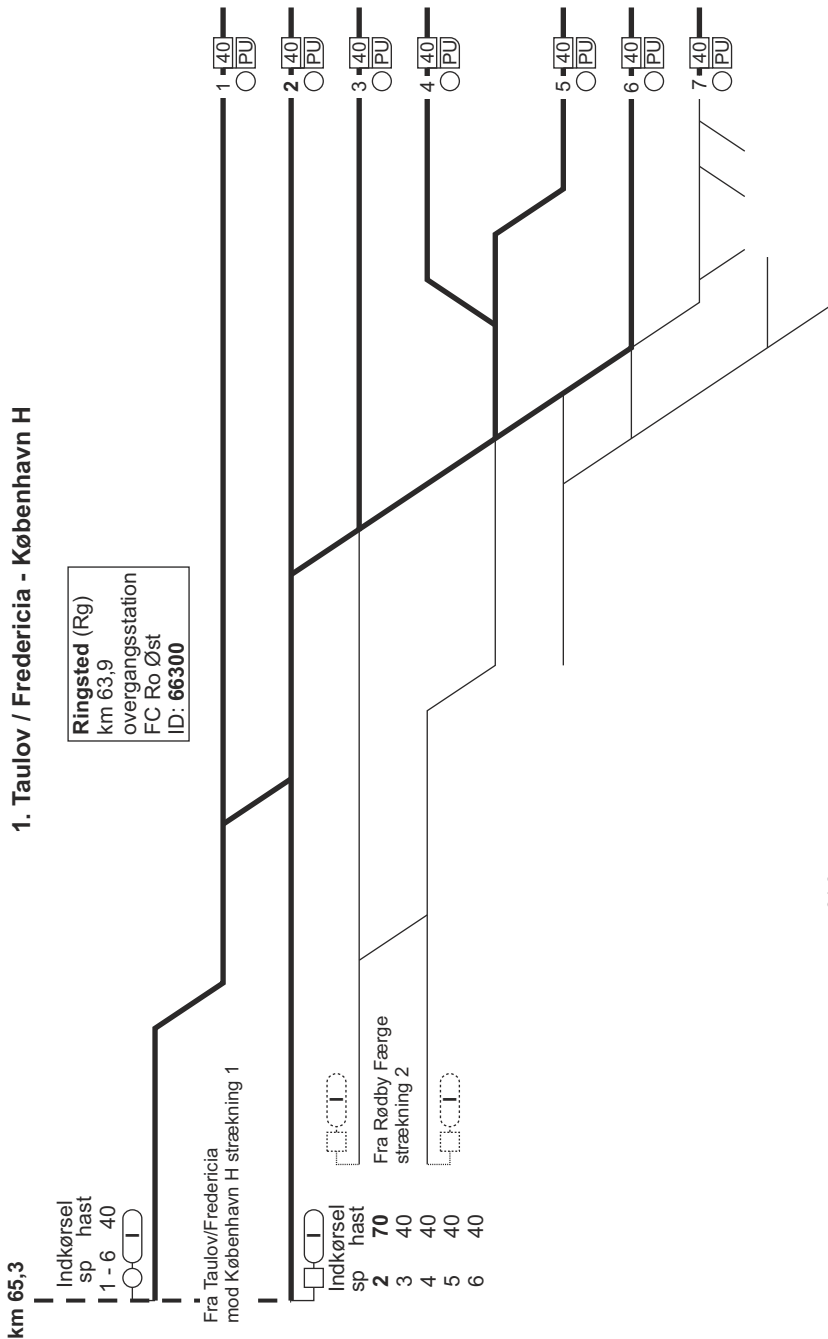

Ringsted (Rg)
 km 63,9
 overgangsstation
 FC Ro Øst
 ID: 66300

Fra Rødby Færge
 strækning 2

64,9
 120
 120
 64,9

180
 160

1. Taulov / Fredericia - København H

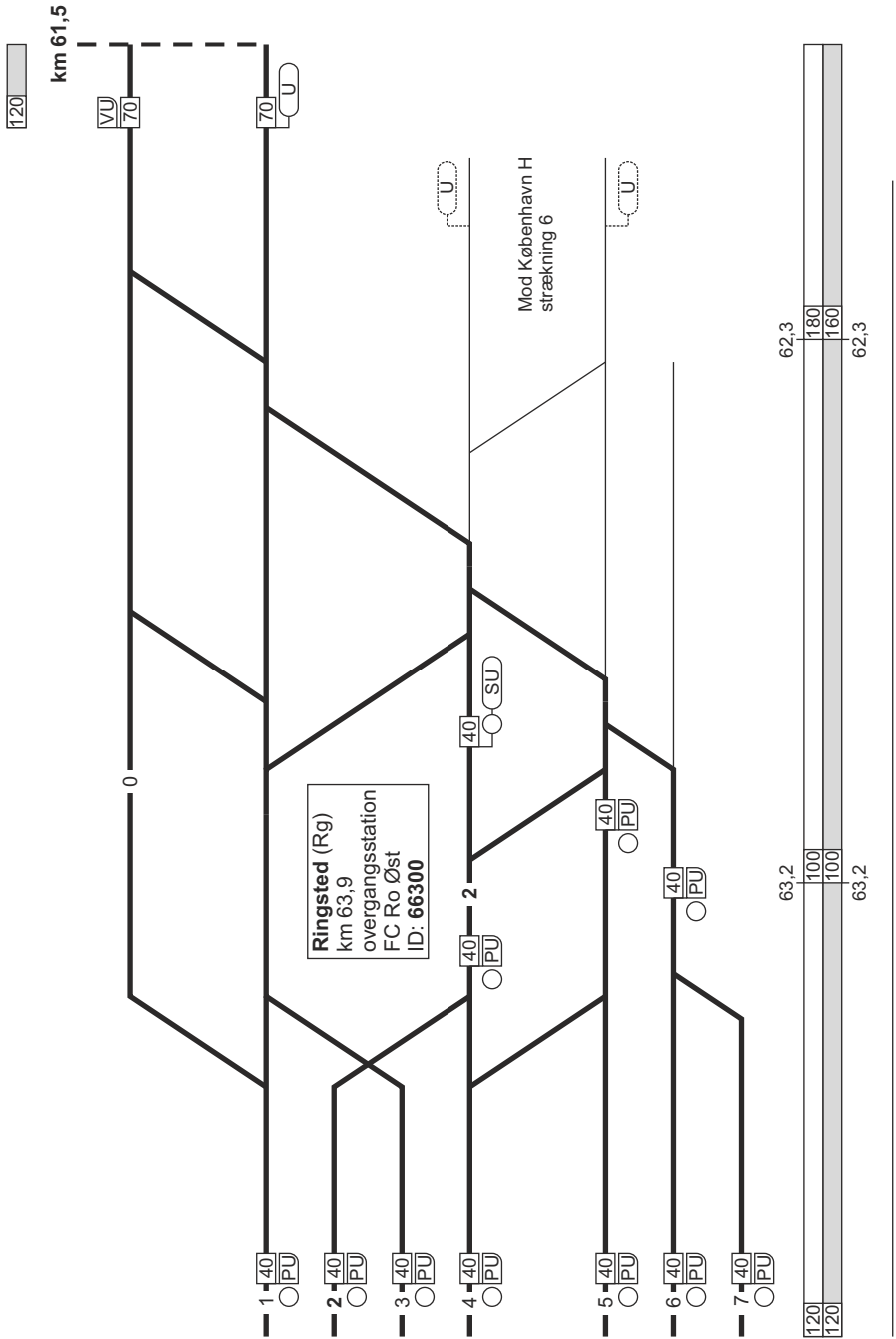

1. Taulov / Fredericia - København H

FC Ro Øst
linjeblok
stigning L

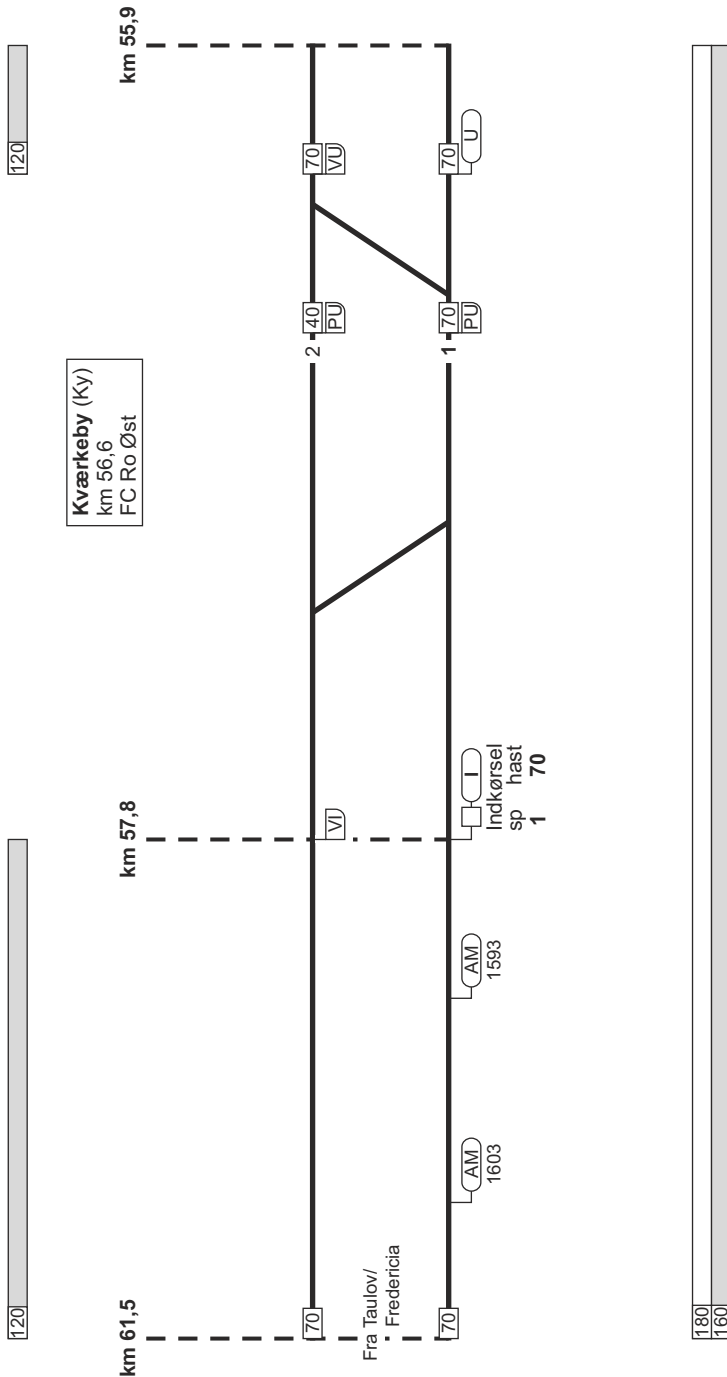

2. Ringsted - Rødby Færge

Strækningshastighed:

| Delstrækning | Strækningshastighed (km/t) |
|---------------------------|----------------------------|
| Ringsted - Næstved | 160 |
| | 180 ¹⁾ |
| Næstved - Vordingborg | 160 |
| Vordingborg - Rødby Færge | 120 |

¹⁾ Strækningshastighed for særlige togsæt. Krav til særlige togsæt fremgår af Banenorm BN2-74.

2. Ringsted - Rødby Færge

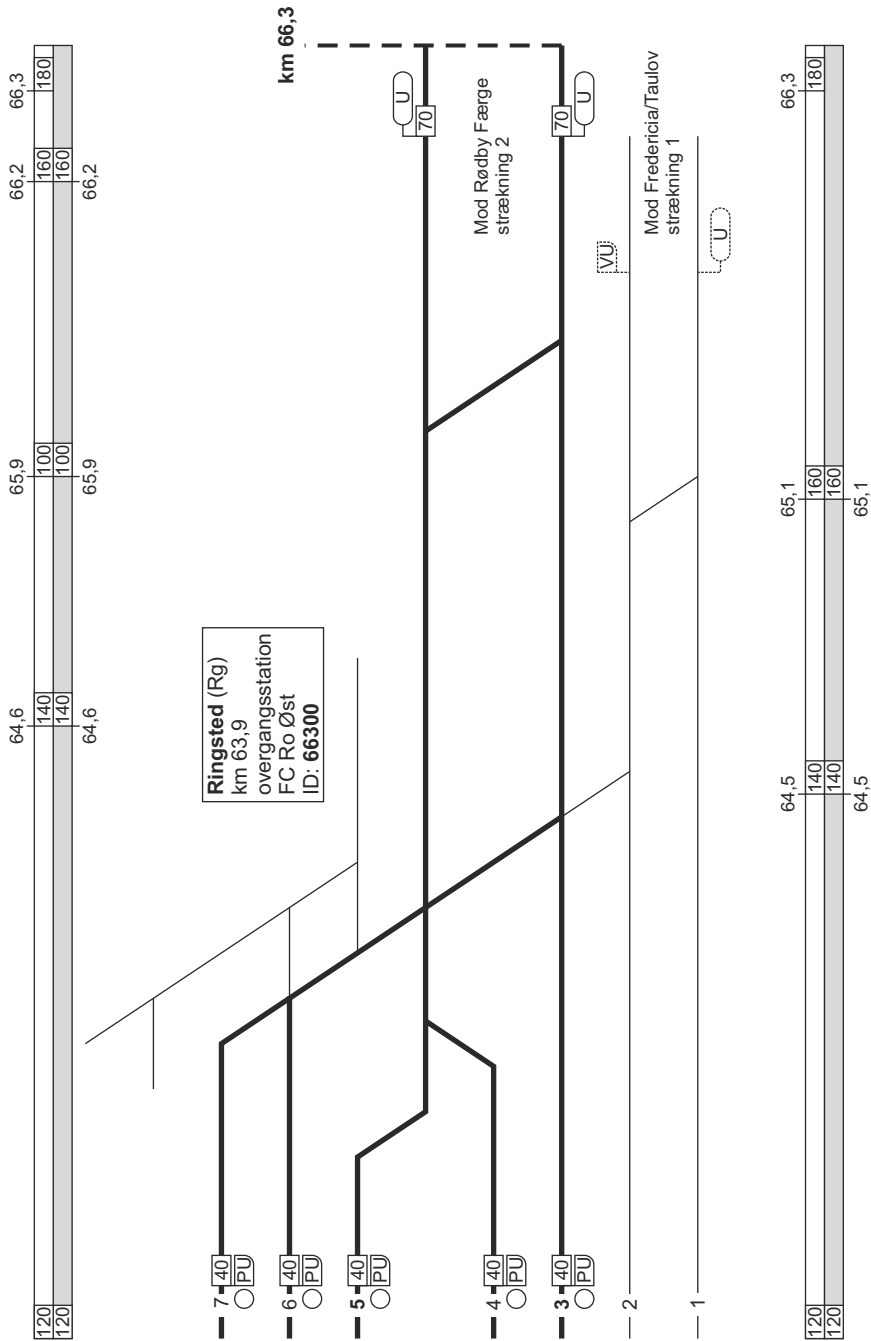

2. Ringsted - Rødby Færge

FC Nf
linjeblok / vekselspor
stigning L



05.10.2020

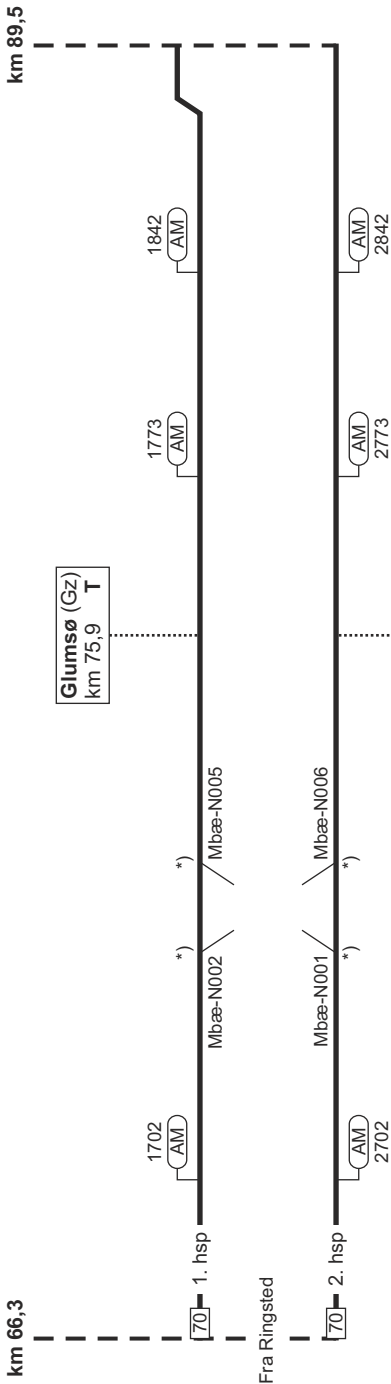

*) Sporskiftet er aflåst



1715

2. Ringsted - Rødby Færge

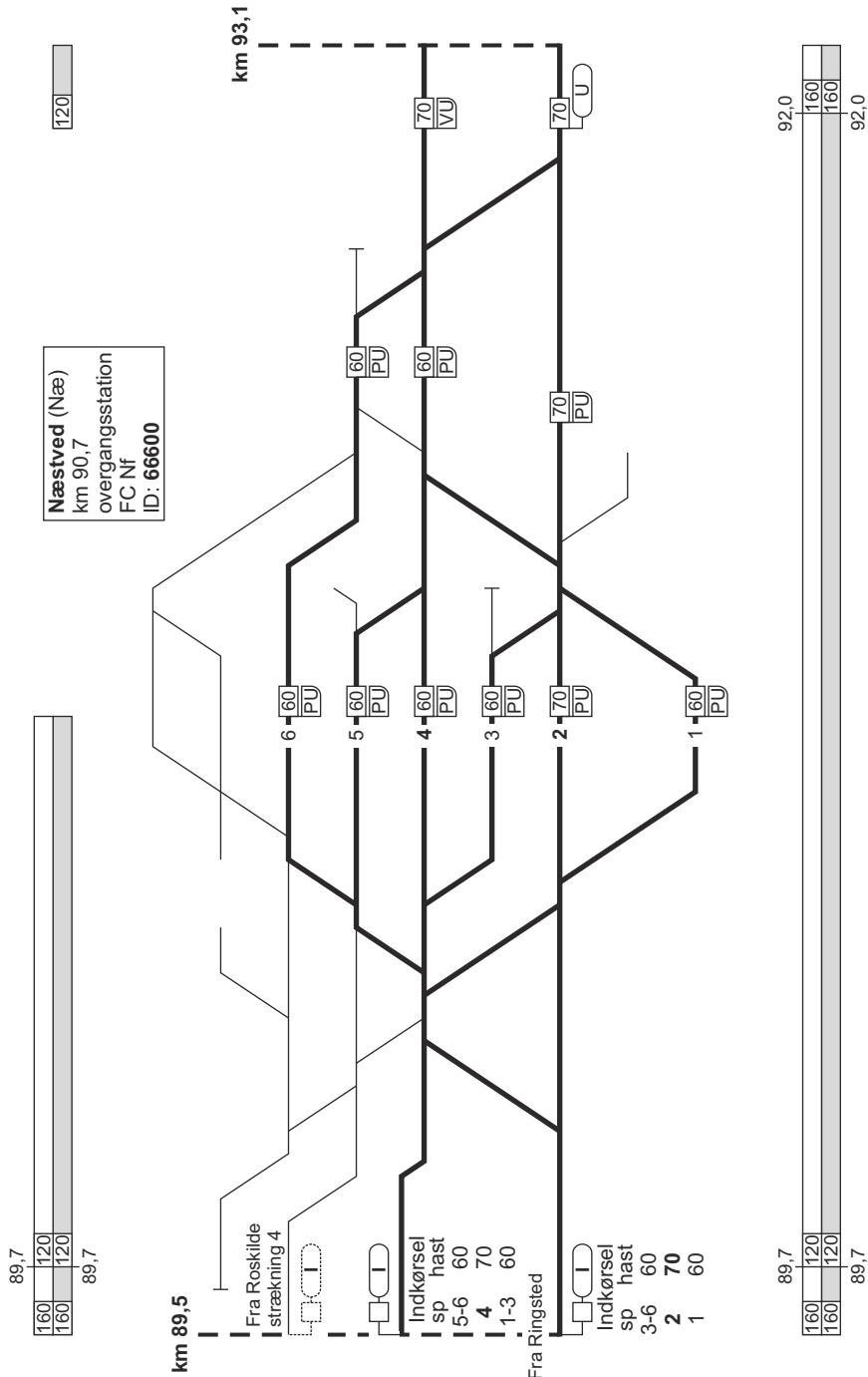

2. Rødby Færge - Ringsted

05.10.2020

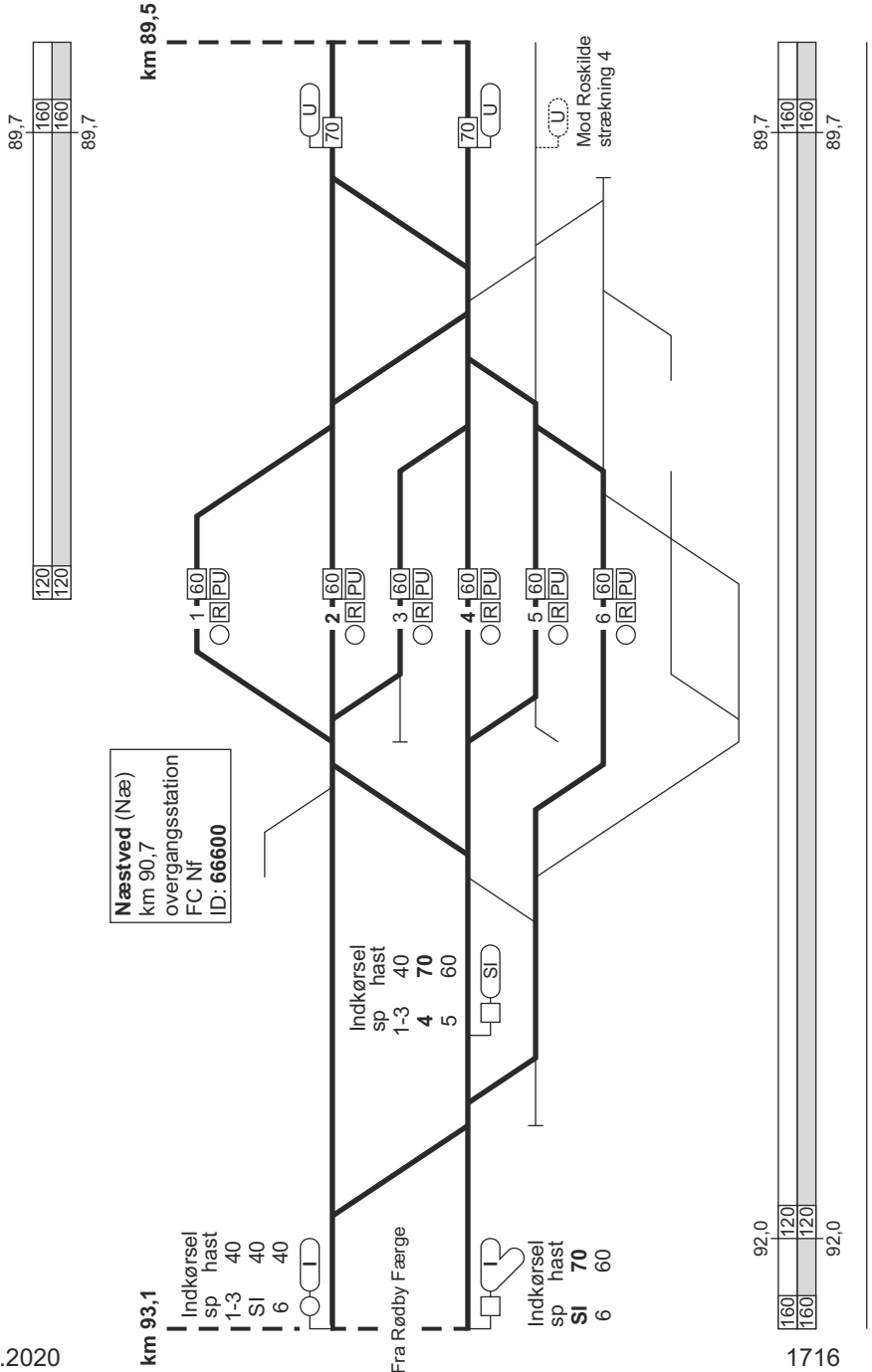

2. Rødby Færge - Ringsted

FC Nf
linjeblok / vekselspor
stigning K

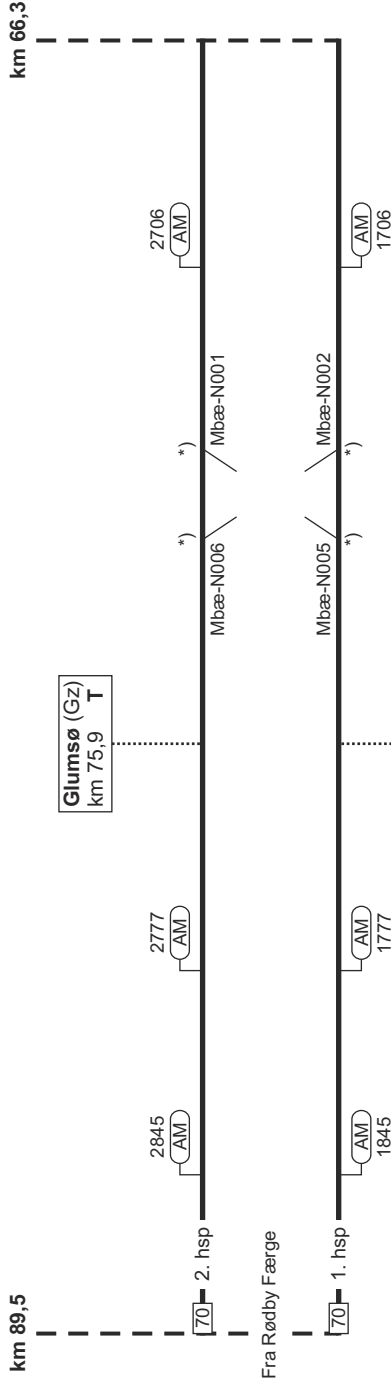

*) Sporskiftet er aflåst



2. Rødby Færge - Ringsted

05.10.2020

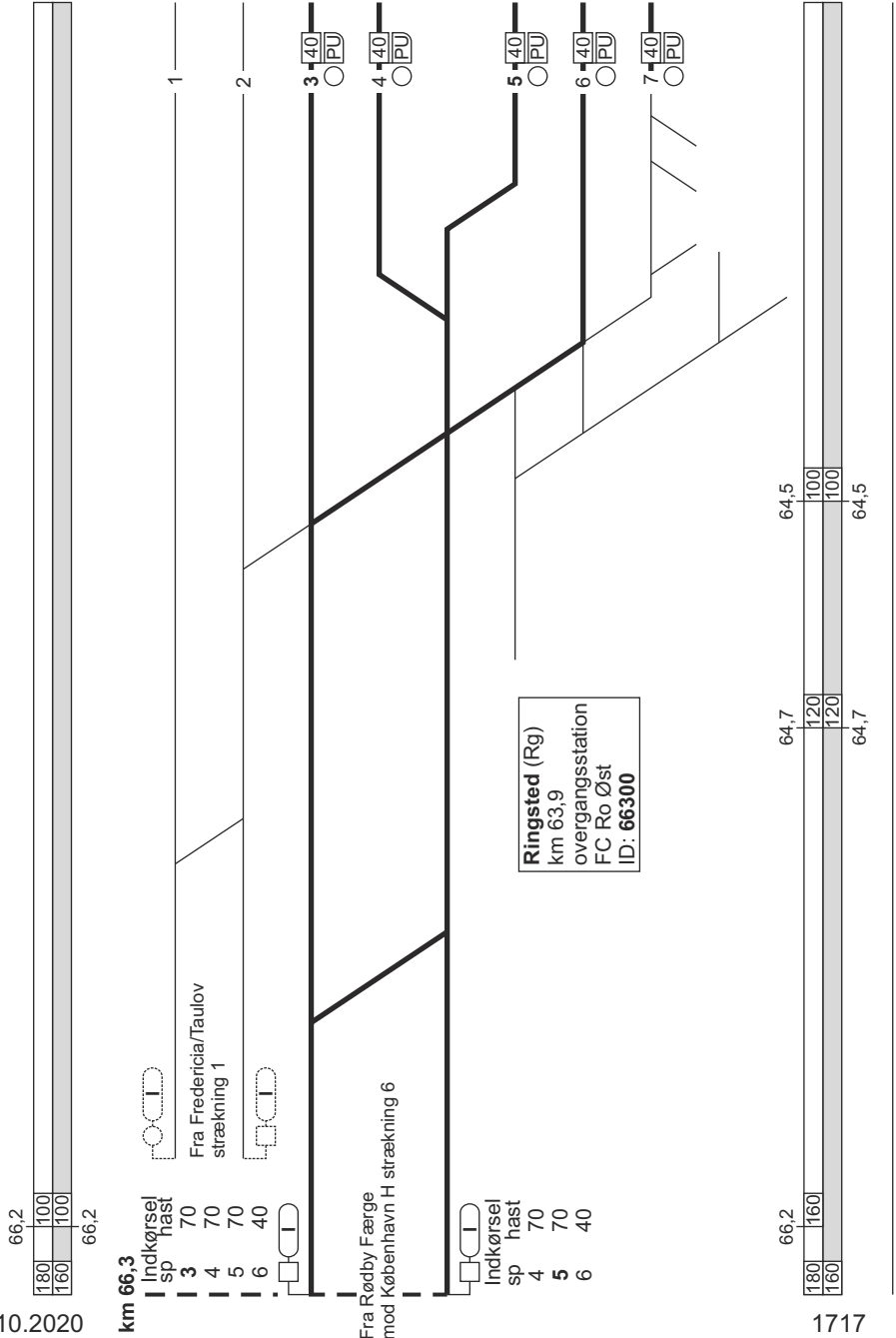

2. Rødby Færgе - Ringsted

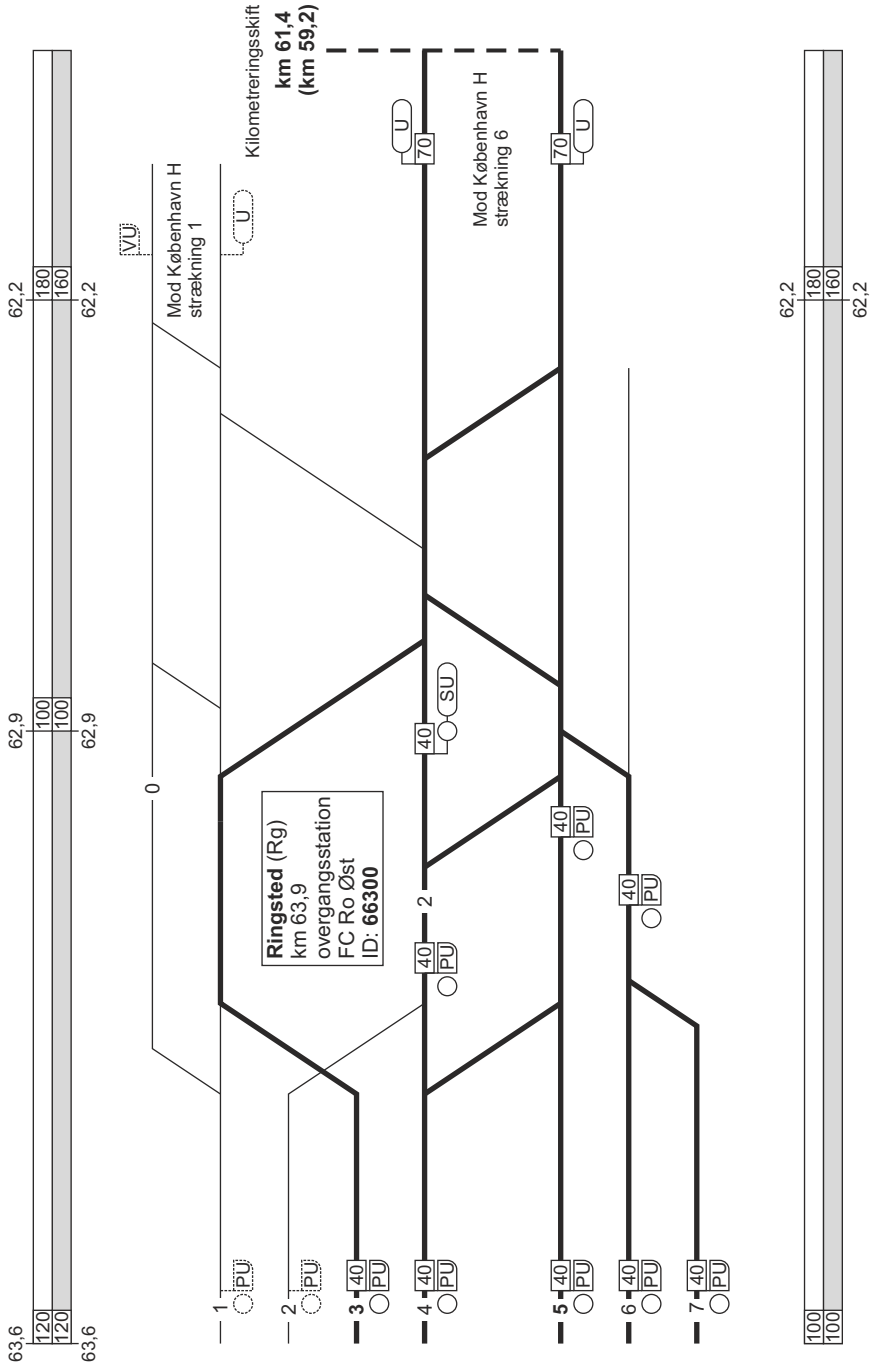

4. Roskilde - (Gadstrup) og (Lille Skensved) - Næstved

FC Ro LilleSyd
linjeblok
stigning K

Holme-Olstrup (Ol)
km 85,3
FC Ro LilleSyd

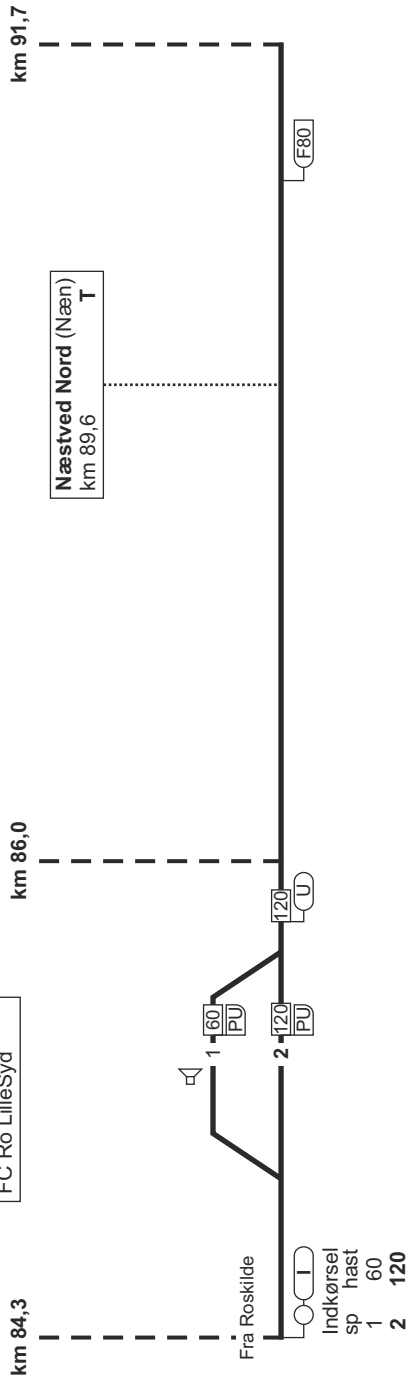

4. Roskilde - (Gadstrup) og (Lille Skensved) - Næstved

Næstved (Næ)
 km 90,7
 overgangsstation
 FC Nf
 ID: 66600

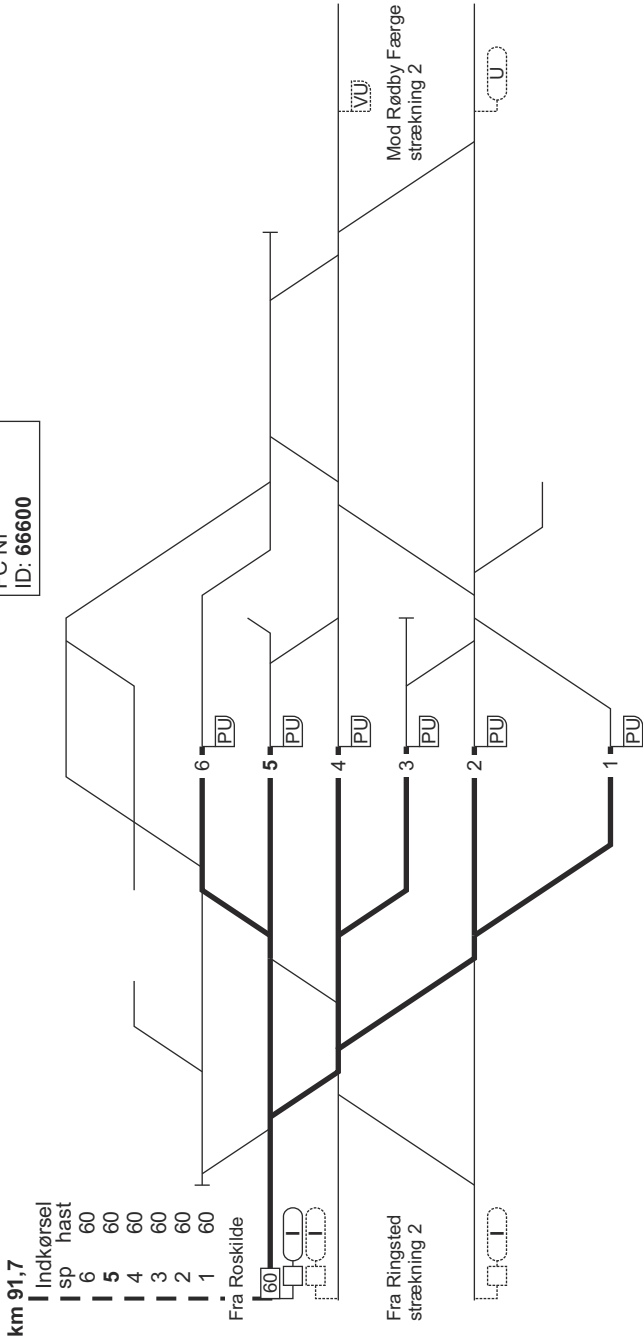

4. Næstved - (Lille Skensved) og (Gadstrup) - Roskilde

Næstved (Næe)
km 90,7
overgangsstation
FC Nf
ID: 66600

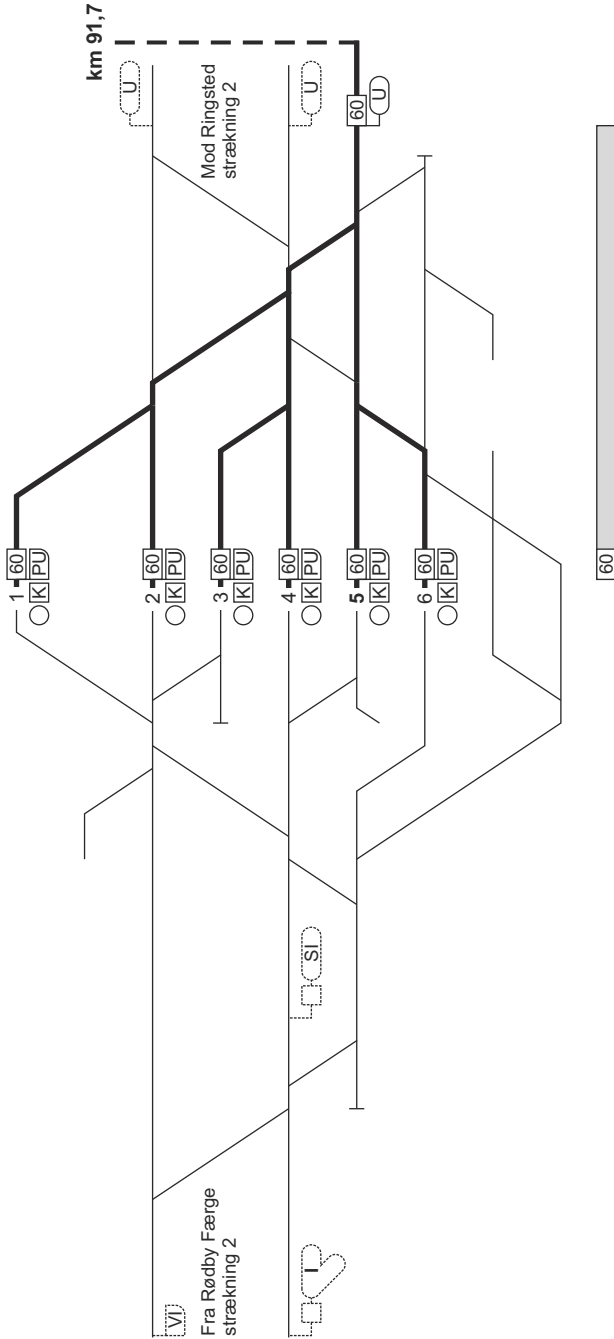

4. Næstved - (Lille Skensved) og (Gadstrup) - Roskilde

FC Ro LilleSyd
linjeblok
stigning J

Holme-Olstrup (Ol)
km 85,3
FC Ro LilleSyd

Næstved Nord (Næan)
km 89,6
T

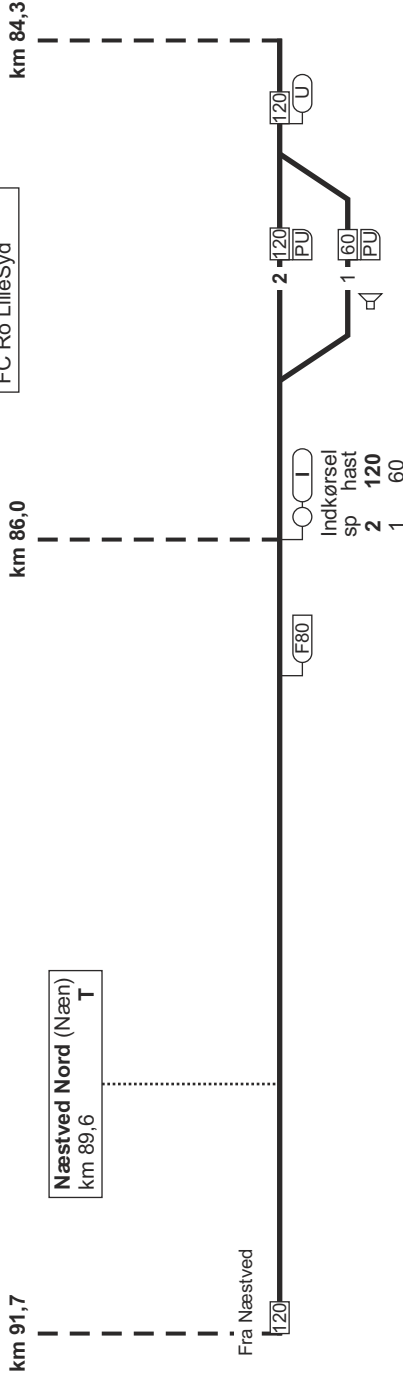

6. København H - Vigerslev - Ringsted

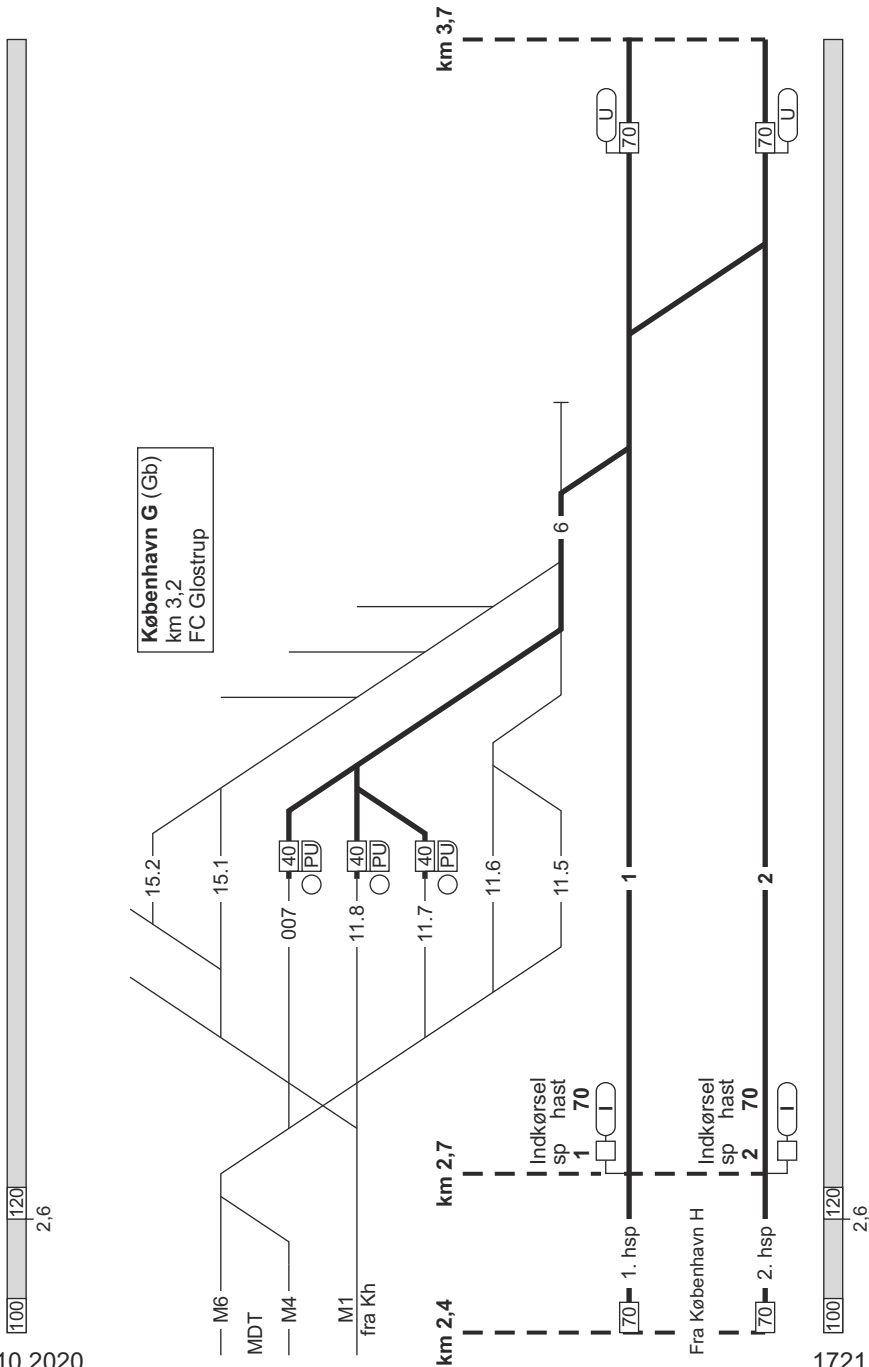

6. København H - Vigerslev - Ringsted

FC Glostrup
linjeblok / vekselspor
stigning L

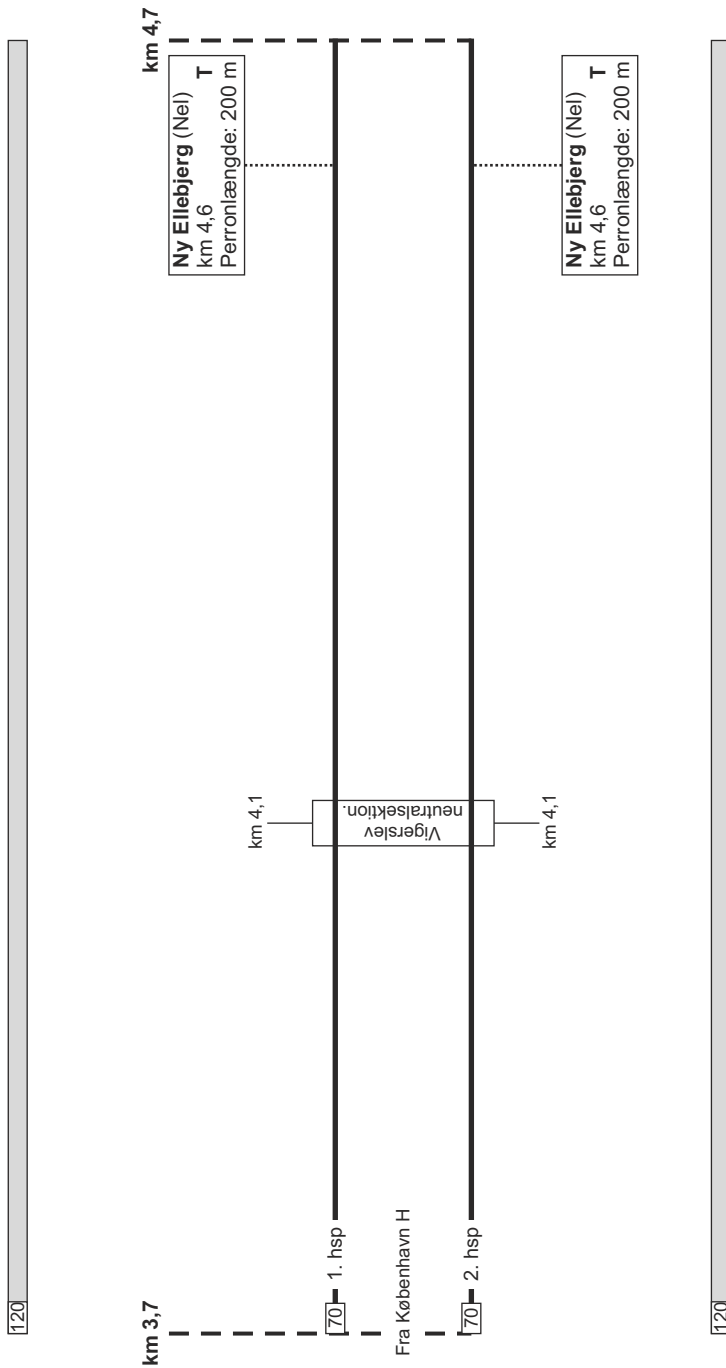

6. København H - Vigerslev - Ringsted

FC Ro Øst
linjeblok / vekselspor
stigning C

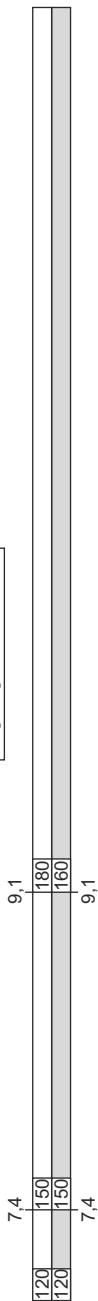

05.10.2020

km 6,3

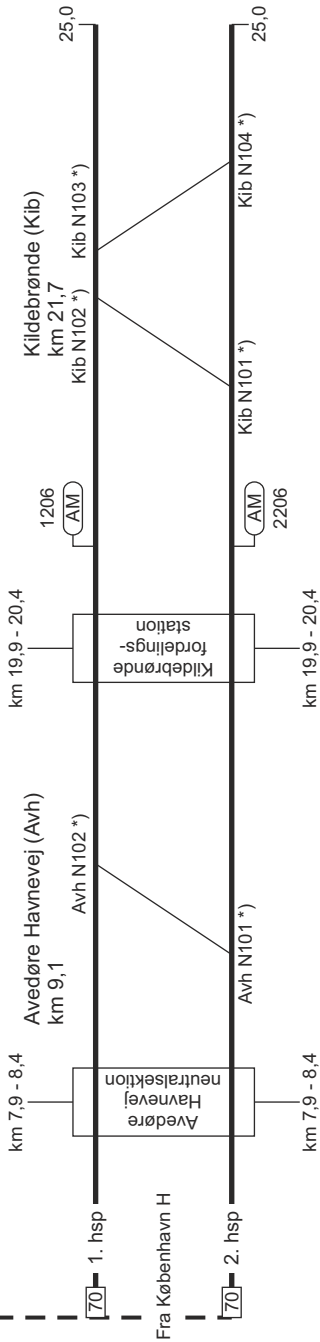

*) Sporskiftet er aflåst

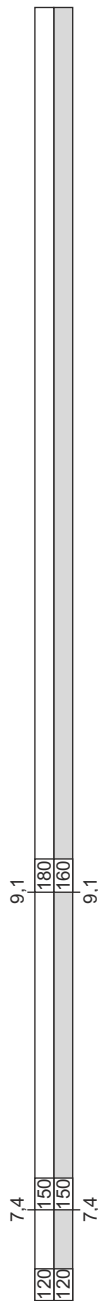

1722

6. København H - Vigerslev - Ringsted

FC Ro Øst
linjeblok / vekselspor
stigning C

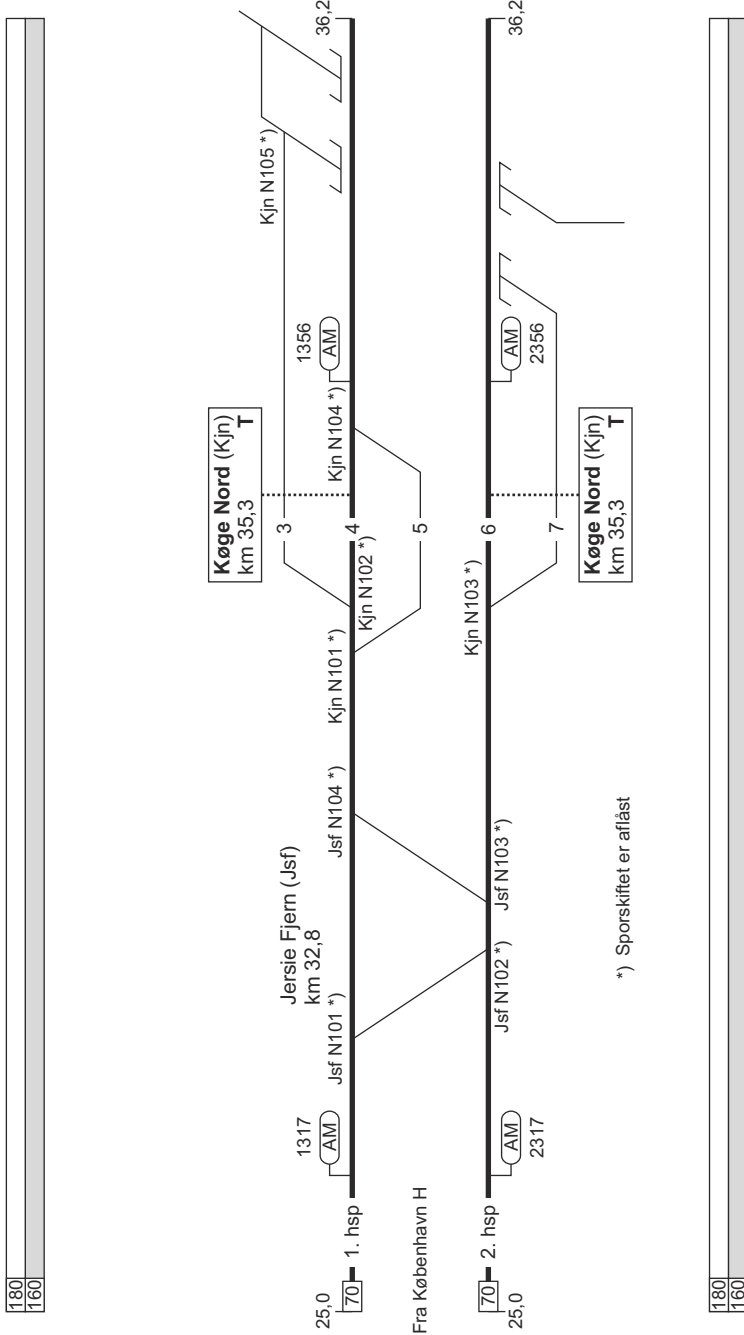

6. København H - Vigerslev - Ringsted

FC Ro Øst
linjeblok / vekselspor
stigning C

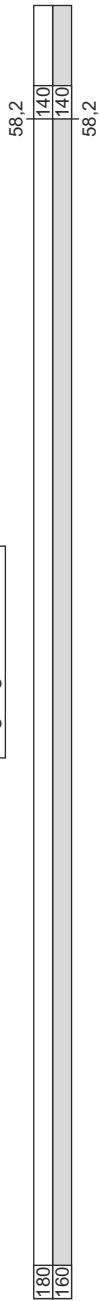

Kilometeringskift
km 59,2
(km 61,4)

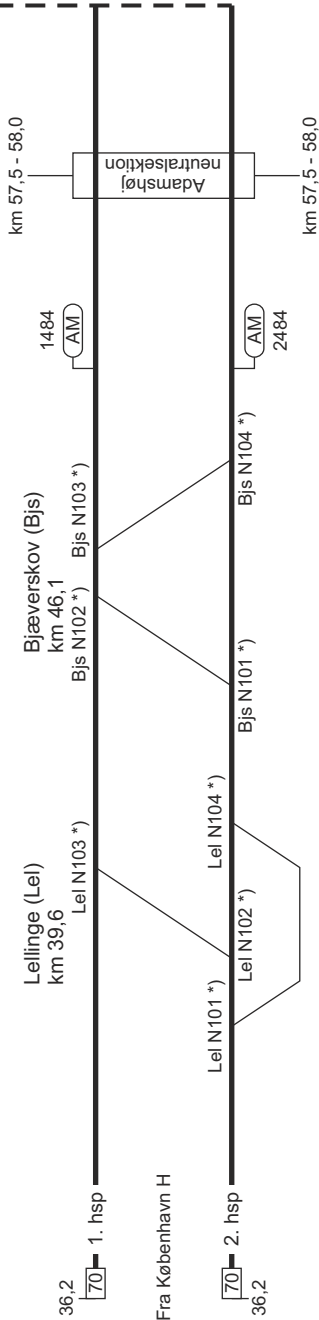

*) Sporskiftet er aflåst

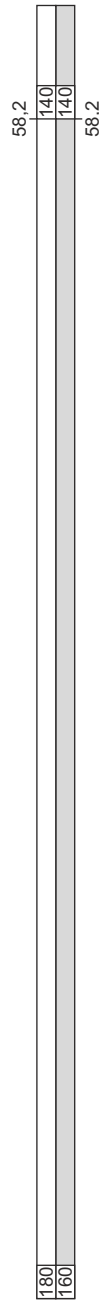

6. København H - Vigerslev - Ringsted

120

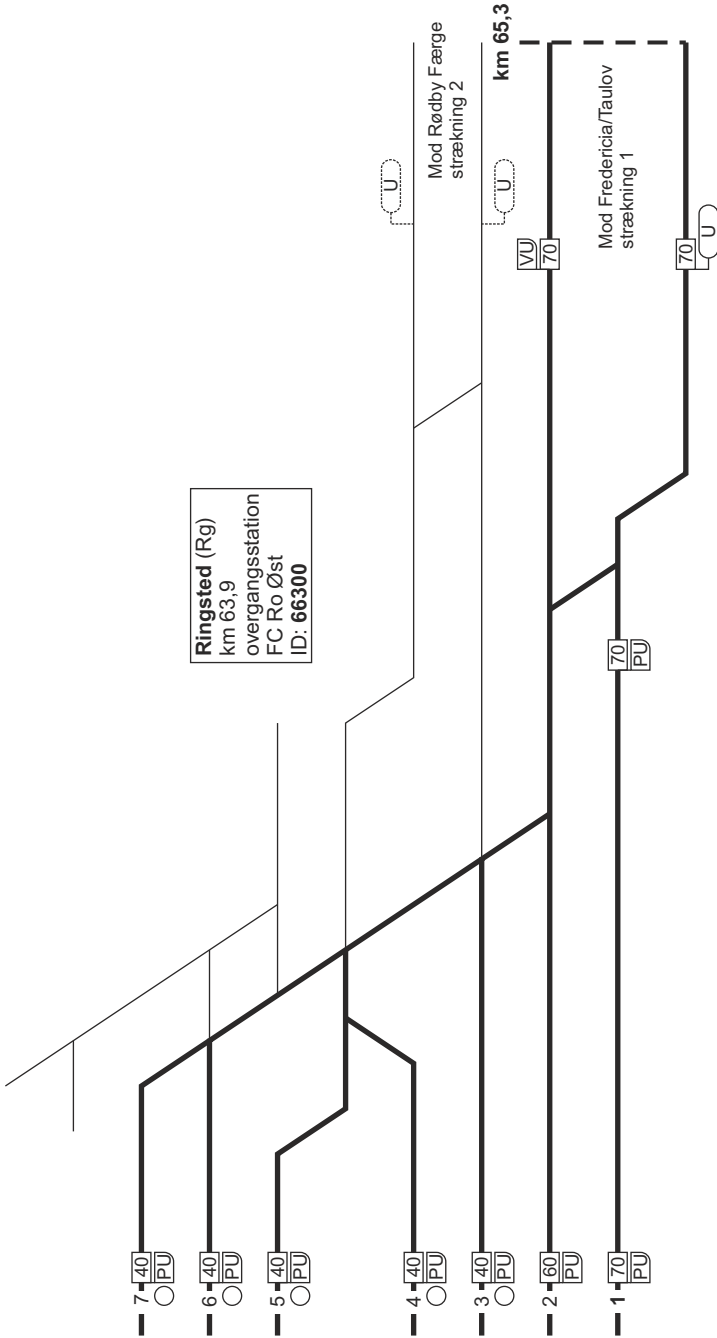

Ringsted (Rg)
km 63,9
overgangsstation
FC Ro Øst
ID: 66300

Mod Rødby Færgesstrækning 2

Mod Fredericia/Taulov strækning 1

km 65,3

64,9

180

160

64,9

120

120

6. København H - Vigerslev - Ringsted

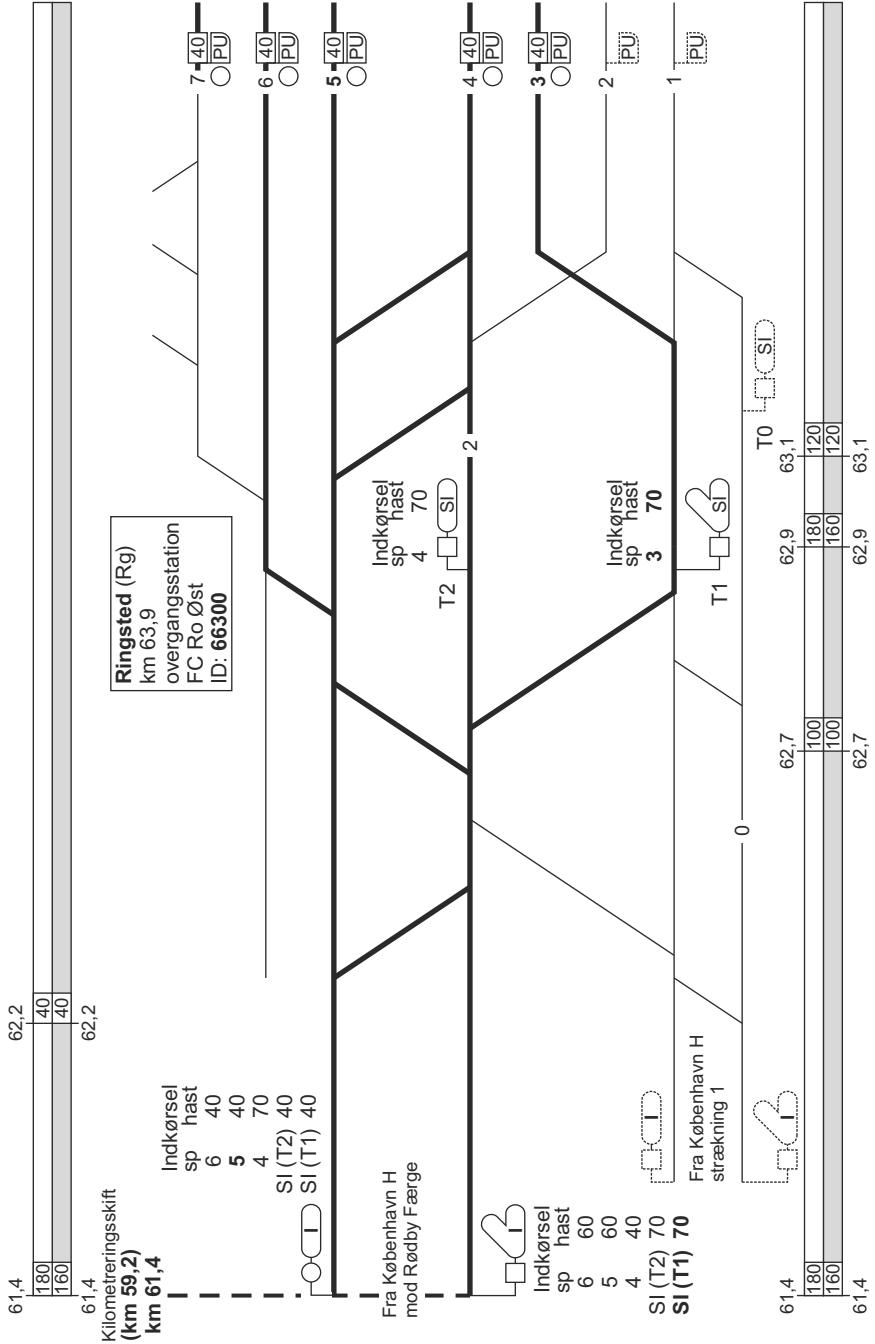

6. Ringsted - Vigerslev - København H

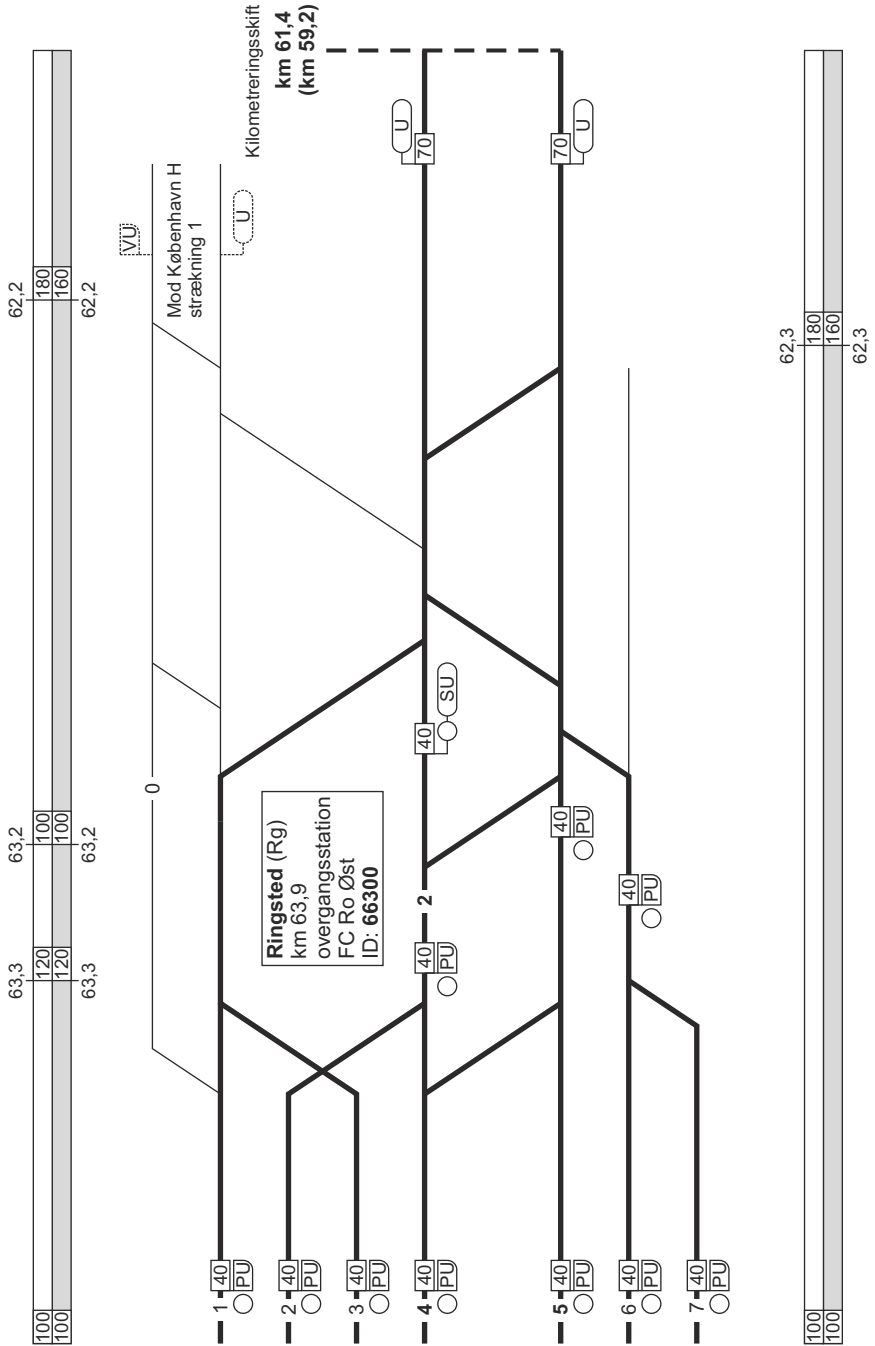

6. Ringsted - Vigerslev - København H

FC Ro Øst
linjeblok / vekselspor
stigning C

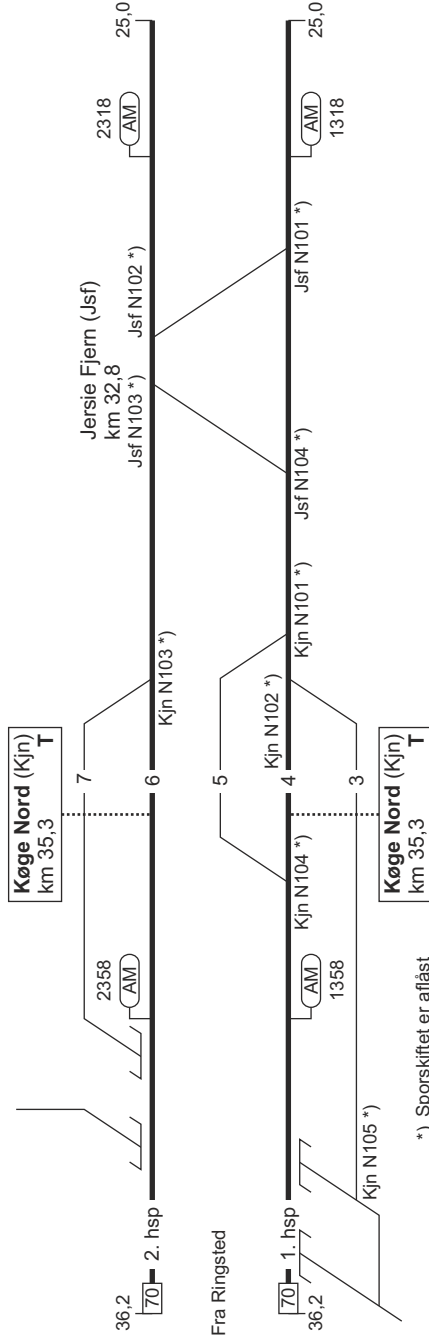
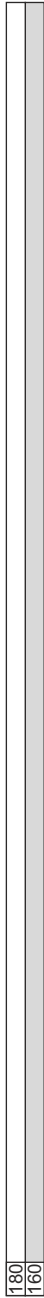

*) Sporskiftet er aflåst



6. Ringsted - Vigerslev - København H

FC Ro Øst
linjeblok / vekselspor
stigning C

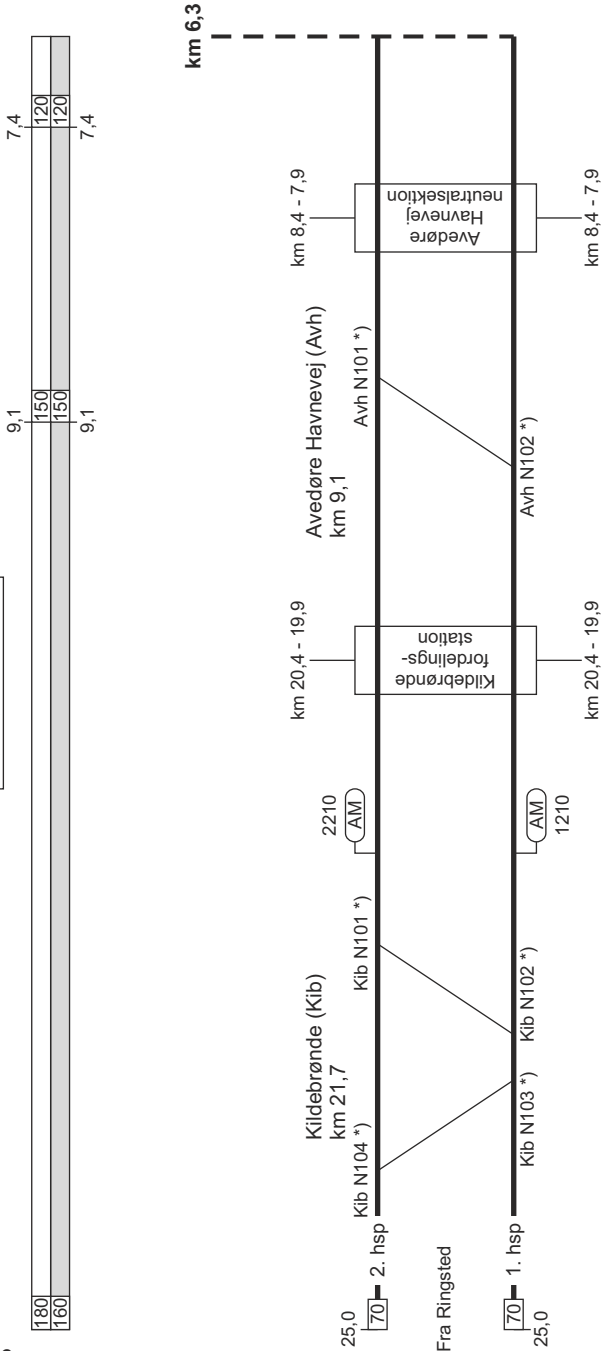

*) Sporskiftet er aflåst

6. Ringsted - Vigerslev - København H

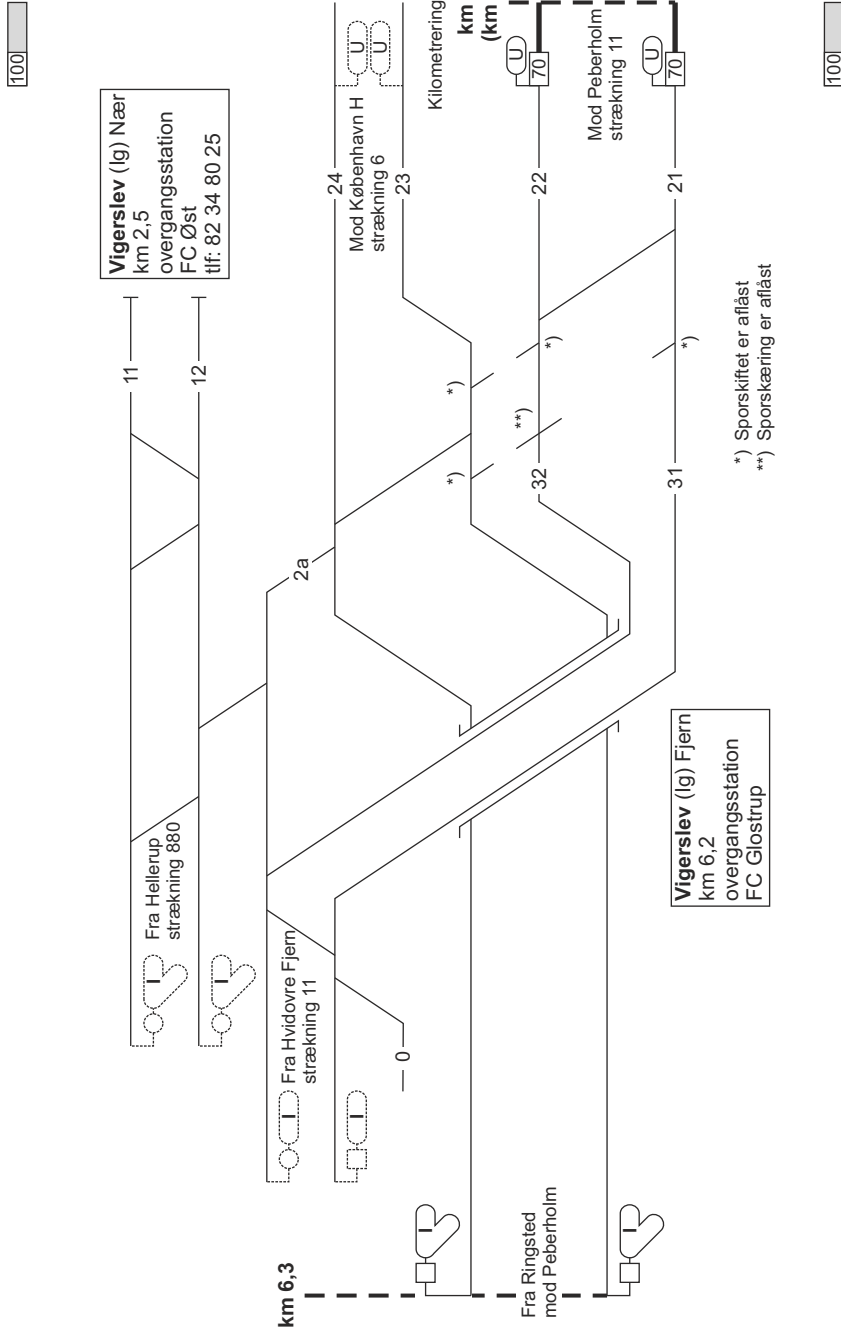

6. Ringsted - Vigerslev - København H

120

05.10.2020

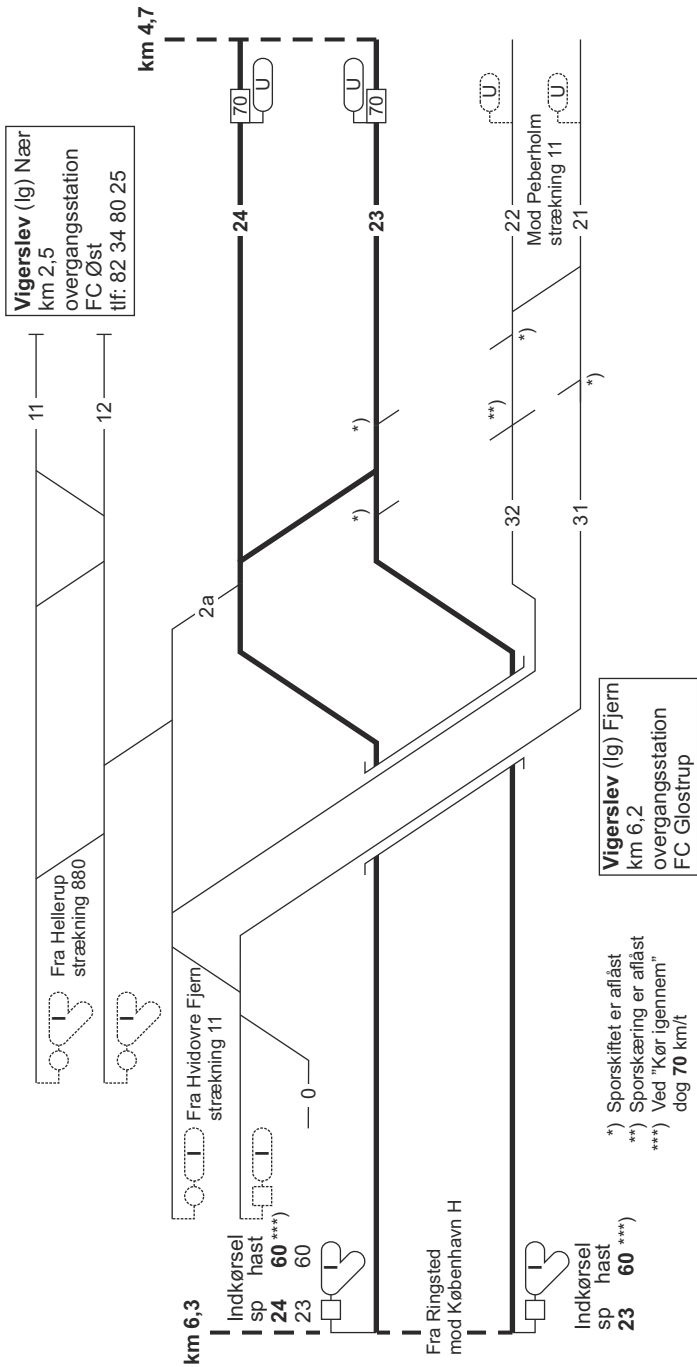

120

1728

6. Ringsted - Vigerslev - København H

FC Glostrup
linjeblok / vekselspor
stigning G

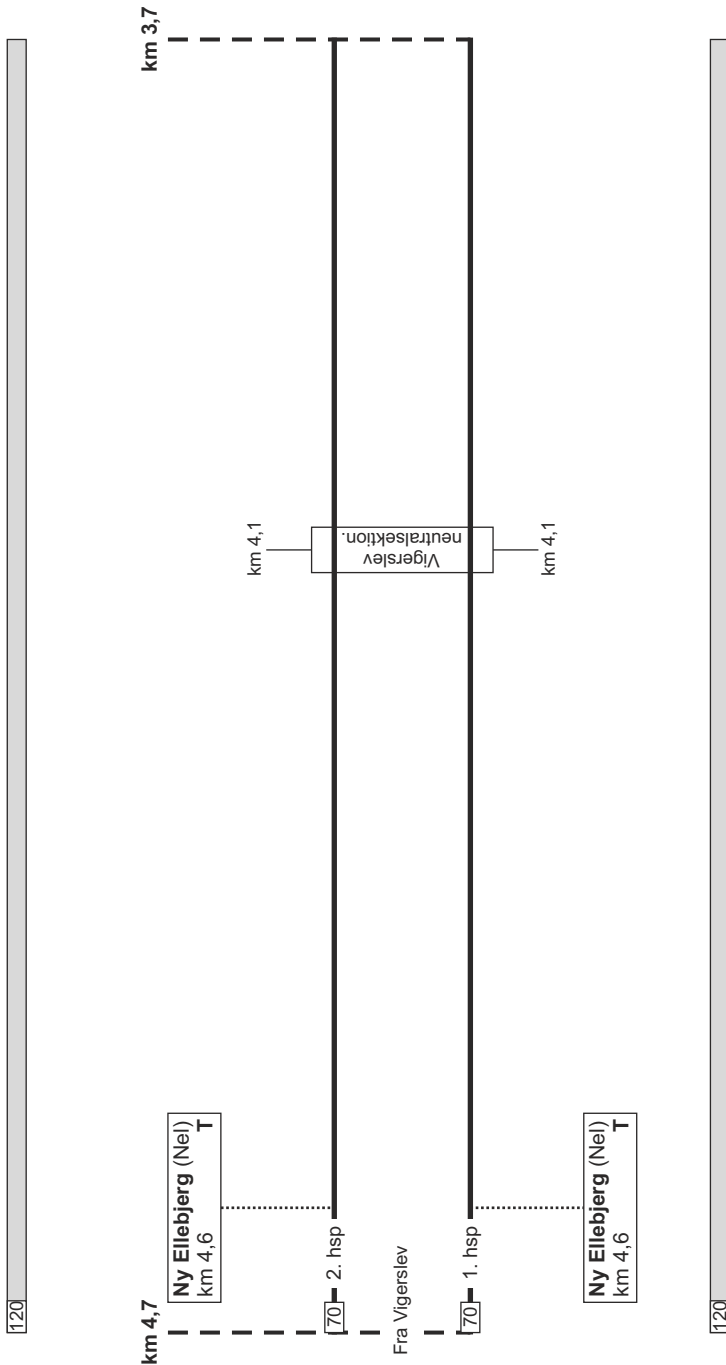

7. Lersøen - Østerport

Strækningshastighed:

| Delstrækning | Strækningshastighed (km/t) |
|---------------------|----------------------------|
| Lersøen - Østerport | 40 |

7. Lersøen - Østerport

FC Øst
 tlf: 82 34 80 25
 linjeblok
 stigning M

Lersøen (Ler)
 km 10,6
 FC Øst
 tlf: 82 34 80 25

Bispebjerg (Bit)
 km 10,3

Bispebjerg (Bit)
 km 10,3

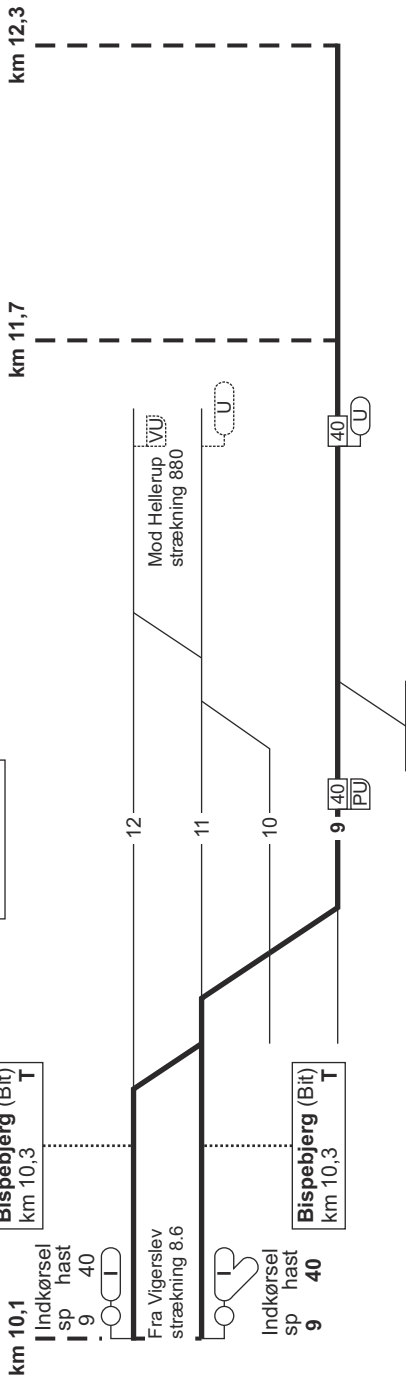

Der er ikke køreledning i spor 9

7. Østerport - Lersøen

| |
|---|
| FC Øst tlf: 82 34 80 25 linjeblok stigning E |
|---|

| |
|--|
| Lersøen (Ler) km 10,6 FC Øst tlf: 82 34 80 25 |
|--|

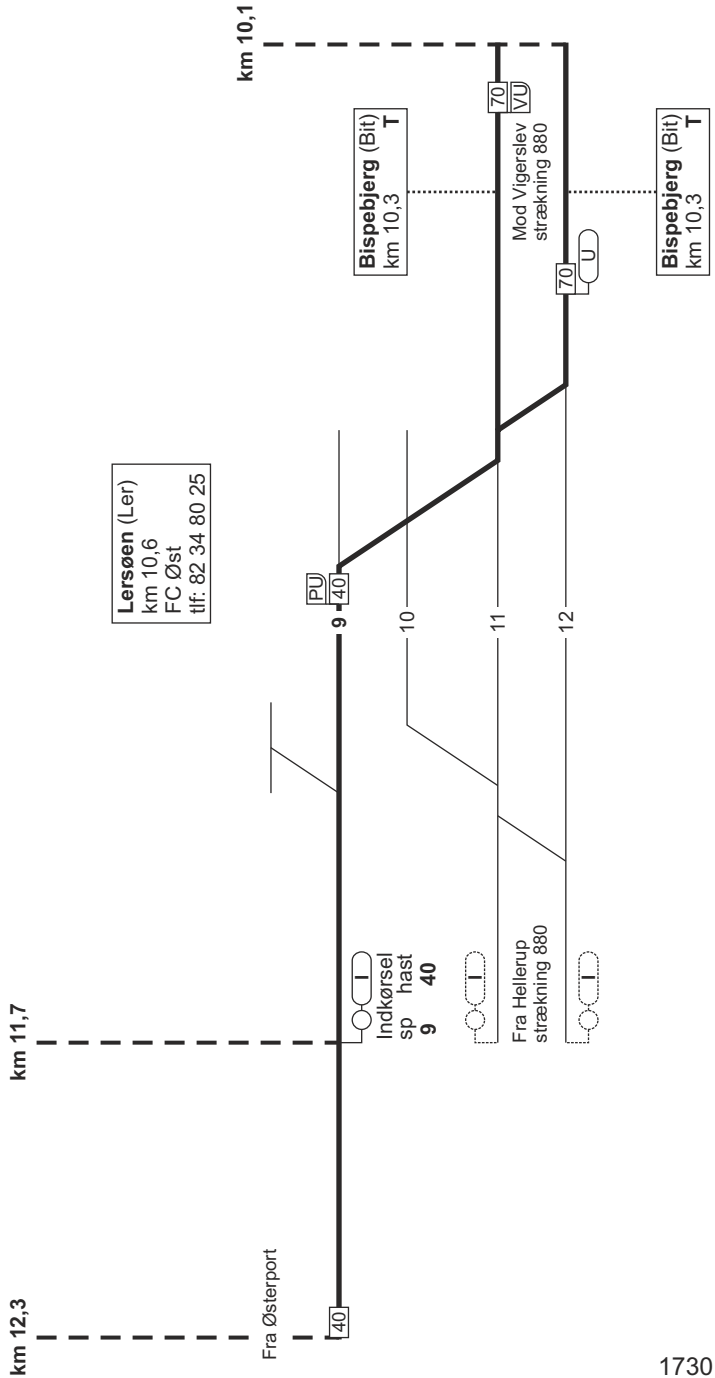

7. Lersøen - Østerport

| | | | | |
|--------------------------|----------------------|---------------------|---------------------|---------------------------|
| Togekspressionssted 1 | Togfølgestation 2 | Sporbenyttelse 3 | Standningssted 4 | Kmp/FC telefonnummer 5 |
|--------------------------|----------------------|---------------------|---------------------|---------------------------|